

TECH TECH CONTROLLERS

USER MANUAL

EU-T-4.1

EU-T-4.2

EN



www.tech-controllers.com

TABLE OF CONTENTS

- I. Safety 3
- II. Device description 4
- III. How to install the controller 4
 - 1. EU-T-4.1 connection diagram 6
 - 2. EU-T-4.2 connection diagram 7
- IV. EU-MW-2 receiver 7
- V. External temperature sensor 8
- VI. First start-up 9
- VII. How to use the regulator 9
 - 1. Principle of operation 9
 - 2. Operation modes 9
 - 3. Main screen view and description 11
 - 4. Controller functions 13
 - 4.1. Main menu 13
 - 4.2. Day of the week 13
 - 4.3. Clock 14
 - 4.4. Day from... 14
 - 4.5. Night from... 14
 - 4.6. Optimum start 14
 - 4.7. Service menu 15
 - 4.8. Weekly program 15
 - 4.9. Pre-set comfort temperature 17
 - 4.10. Pre-set economical temperature 17
 - 4.11. Pre-set temperature hysteresis 17
 - 4.12. Temperature sensor calibration 17
- VIII. Technical data 18

JG. 2021.05.28

*The pictures and diagrams are for illustration purposes only.
The manufacturer reserves the right to introduce some changes.*

I. SAFETY

Before using the device for the first time the user should read the following regulations carefully. Not obeying the rules included in this manual may lead to personal injuries or controller damage. The user's manual should be stored in a safe place for further reference.

In order to avoid accidents and errors it should be ensured that every person using the device has familiarized themselves with the principle of operation as well as security functions of the controller. If the device is to be sold or put in a different place, make sure that the user's manual is stored with the device so that any potential user has access to essential information about the device.

The manufacturer does not accept responsibility for any injuries or damage resulting from negligence; therefore, users are obliged to take the necessary safety measures listed in this manual to protect their lives and property.



WARNING

- **A live electrical device!** Make sure the regulator is disconnected from the mains before performing any activities involving the power supply (plugging cables, installing the device etc.)
- The device should be installed by a qualified electrician.
- The device should not be operated by children.



WARNING

- The device may be damaged if struck by a lightning. Make sure the plug is disconnected from the power supply during a thunderstorm.
- Any use other than specified by the manufacturer is forbidden.
- The device should be periodically checked.

Changes in the merchandise described in the manual may have been introduced subsequent to its completion on 28.05.2021. The manufacturer retains the right to introduce changes to the structure or colours. The illustrations may include additional equipment. Print technology may result in differences in the colours shown.

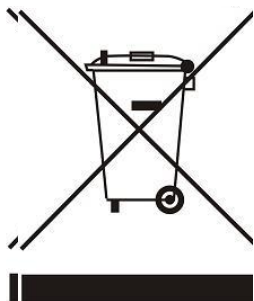

We are committed to protecting the environment. Manufacturing electronic devices imposes an obligation of providing for environmentally safe disposal of used electronic components and devices. Hence, we have been entered into a register kept by the Inspection for Environmental Protection. The crossed-out bin symbol on a product means that the product may not be disposed of to household waste containers. Recycling of waste helps to protect the environment. The user is obliged to transfer their used equipment to a collection point where all electric and electronic components will be recycled.

II. DEVICE DESCRIPTION

The EU-T-4.1/EU-T-4.2 room regulator is intended for controlling the heating device (e.g. gas, oil or electric boiler or the boiler controller).

Its main task is to maintain the pre-set temperature in the flat by sending a signal to the heating/cooling device (contact opening) when the desired temperature is reached.

Advanced software enables the regulator to fulfil a wide range of functions:

- maintaining the pre-set room temperature
- manual mode
- day/night program
- weekly control
- Optimum Start
- heating/cooling

Controller equipment:

- front panel made of glass
- built-in temperature sensor
- batteries

III. HOW TO INSTALL THE CONTROLLER

The controller should be installed by a qualified electrician.

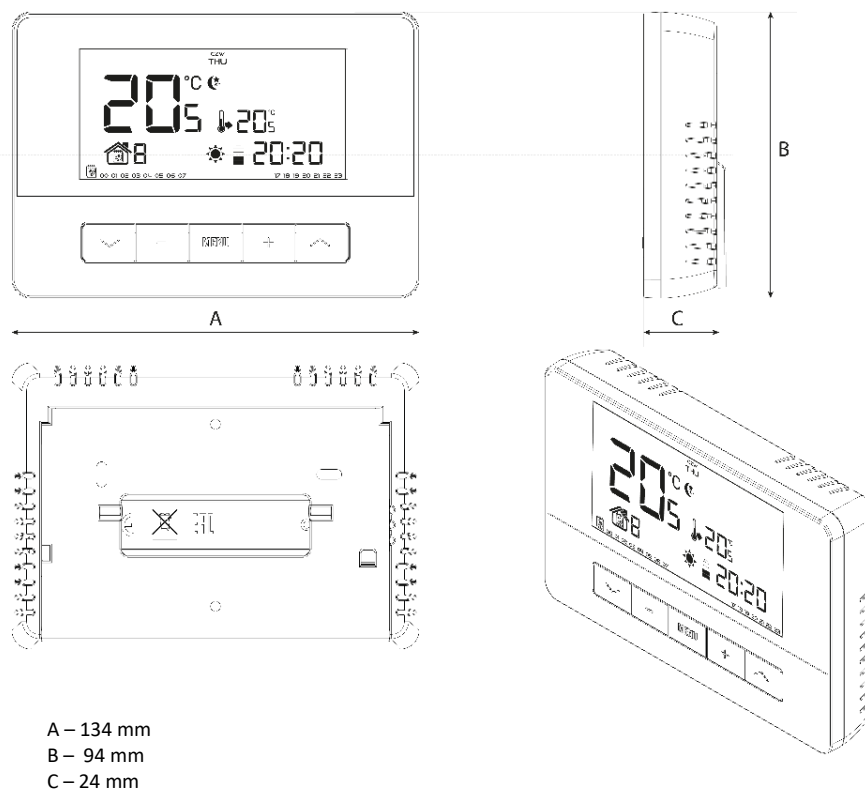

USER MANUAL

The EU-T-4.1/EU-T-4.2 regulator may be put in any place (1) or used as a wall-mountable panel (2).

- 1) The regulator may be supported with a stand which should be attached to the back cover.

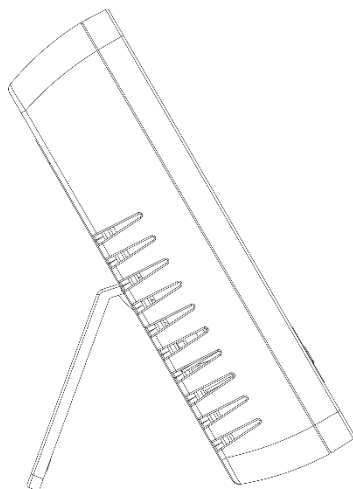

- 2) In order to hang the regulator on the wall, remove the stand carefully.

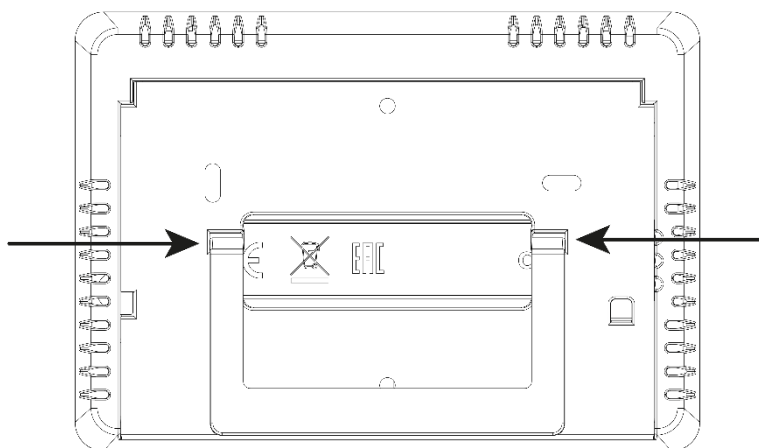

In order to insert batteries, remove the back cover.

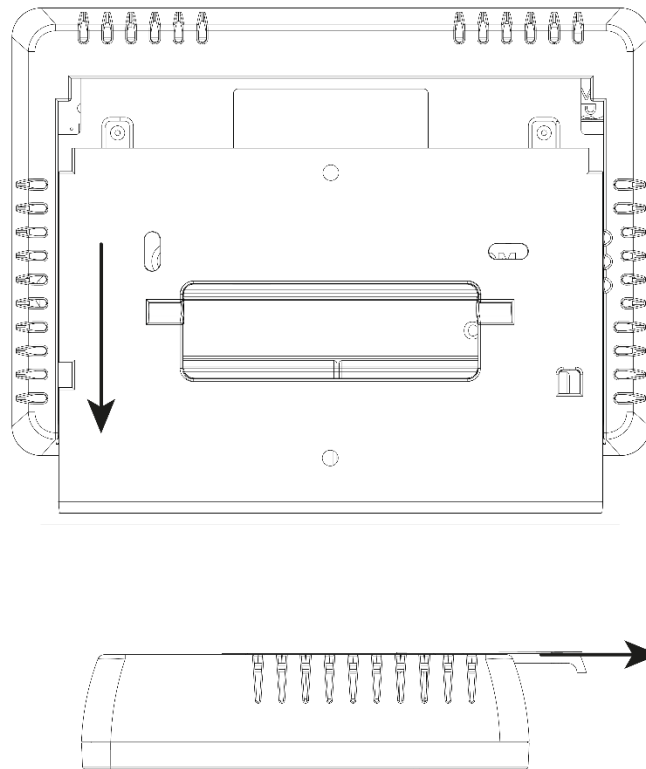

1. EU-T-4.1 CONNECTION DIAGRAM

The room regulator should be connected to the heating device or the CH boiler controller with the use of a two-core cable. The diagram below illustrates how to connect the devices.

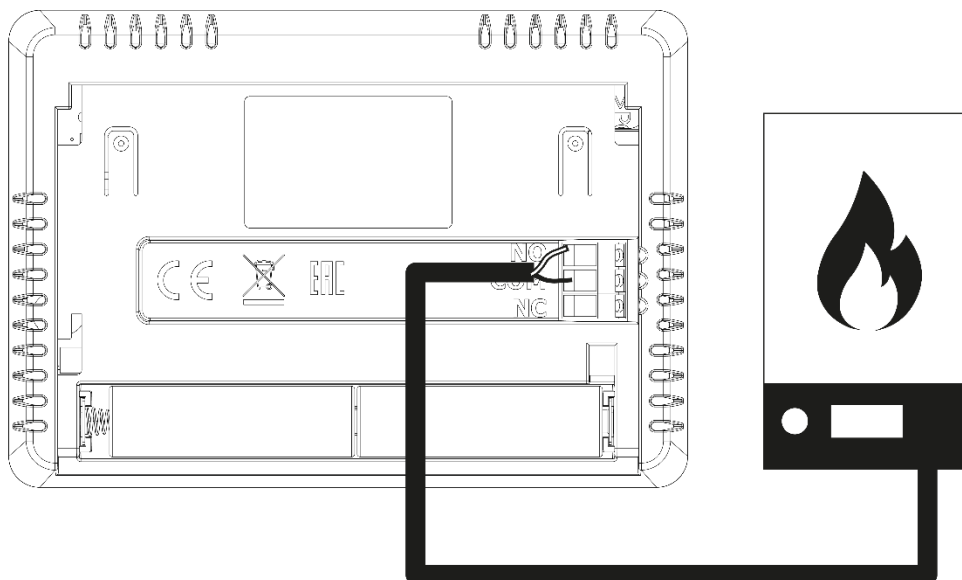

WARNING

If pump manufacturer requires an external main switch, power supply fuse or additional residual current device selective for distorted currents it is recommended not to connect pumps directly to pump control outputs. To avoid damaging to the device, an additional safety circuit must be used between the regulator and the pump. The manufacturer recommends the ZP-01 pump adapter, which must be purchased separately.

2. EU-T-4.2 CONNECTION DIAGRAM

In the case of wireless connection, use the above diagrams - a two-core communication cable should be connected to appropriate ports in the receiver.

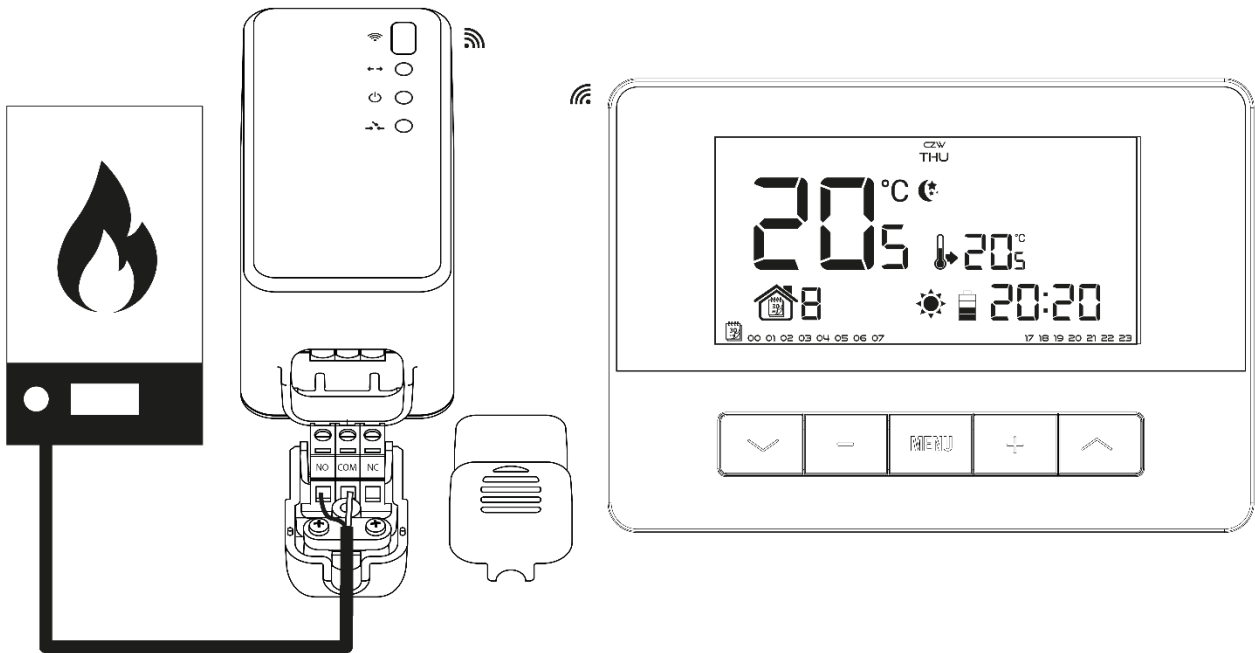

IV. EU-MW-2 RECEIVER

The EU-T-4.2 regulator communicates with the heating device (or the CH boiler controller) by means of a radio signal sent to the EU-MW-2 receiver. Such a receiver is connected to the heating device (or the CH boiler controller) by means of a two-core cable, and communicates with the room regulator using a radio signal.

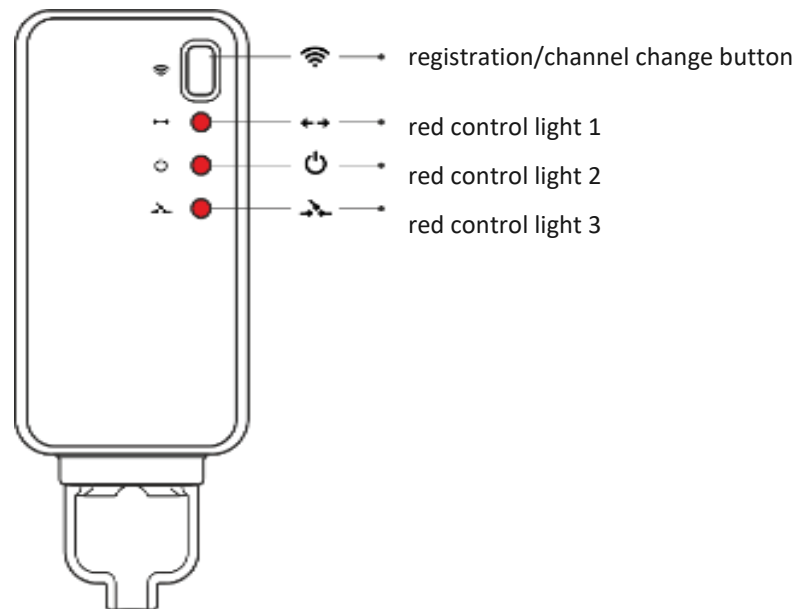

The receiver has three control lights:

- red control light 1 – it signalises data reception and goes on during channel change;
- red control light 2 – indicates receiver operation;
- red control light 3 – goes on when the room temperature fails to reach the pre-set value – the heating device is switched on

NOTE

In case of no communication (e.g. due to discharged battery), the receiver automatically disables the heating device after 15 minutes.

How to change the communication channel:

Channel 35 is the default communication channel in the room regulator. The channel may be easily changed (if the current channel is used by other devices). To change the channel, press and hold the channel change button on the receiver for about 10 seconds until the red control light 1 goes on. Next, change the communication channel in the room regulator following the procedure described in the section: *Controller functions*. The red control light 1 on the receiver should go off.

V. EXTERNAL TEMPERATURE SENSOR

The EU-T-4.2 room regulator may optionally be equipped with an external temperature sensor. The sensor should be mounted in a shaded place so that it is not affected by the weather conditions. The current temperature reading will be sent to the room regulator every few minutes and it will be displayed on the main screen.

The external sensor communicates with the room regulator via radio signal. Both the room regulator and the external sensor are pre-configured to operate on channel 35, but the user may easily change the channel (if the current channel is used by other devices).

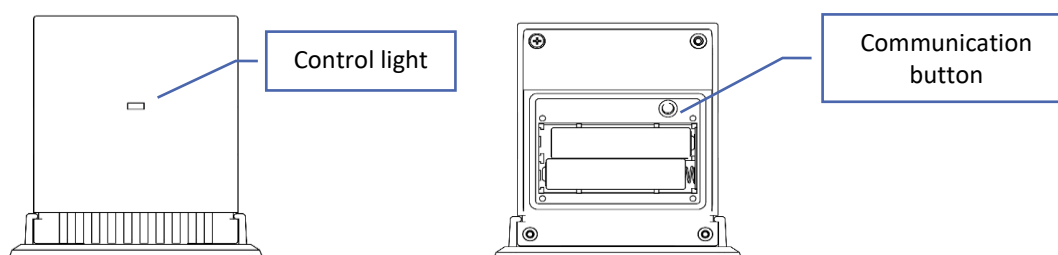
**How to change the communication channel:**

In order to change the channel, press and hold the channel change button. When the control light on the sensor flashes, the process of channel change has been initiated. Keep holding the button and wait until the light starts flashing again. The number of flashes corresponds to the first digit of the desired channel number.

Release the button after the desired number of flashes and press it again to set the second digit of the channel number – the control light flashes quickly twice. Hold the button and wait until the light flashes the desired number of times. When the button is released, the control light flashes twice – the new communication channel has been set.

NOTE: In case of a one-digit channel number (channels 0÷9) set 0 as the first digit.

Example 1:

28 is the desired communication channel. In order to select this channel, set the first digit - 2, and the second digit – 8. Press and hold the channel change button - the control light flashes quickly once - the process of channel change has been initiated. Keep holding the button and wait until the light flashes two more times (the first digit of the channel number – 28).

Release the button and press it again – the control light flashes quickly twice – the process of setting the second digit has been initiated. Keep holding the button and wait until the light flashes 8 times.

When the button is released, the control light flashes quickly twice – the new communication channel has been successfully set.

Example 2:

7 is the desired communication channel. In order to select this channel, set the first digit - 0, and the second digit – 7.

Press and hold the channel change button - the control light flashes quickly once - the process of channel change has been initiated. As the first digit is 0, release the button before the control light flashes again.

Press the button again – the control light flashes quickly twice – the process of setting the second digit has been initiated. Keep holding the button and wait until the light flashes 7 times (the second digit of the desired number).

USER MANUAL

When the button is released, the control light flashes quickly twice – the new communication channel has been successfully set.

In case of errors in the channel change process, the control light goes on for about 2 seconds. In such a case the channel will not be changed.

VI. FIRST START-UP

In order for the regulator to operate correctly, follow these steps when starting the device for the first time:

1. Insert the batteries - in order to do it, remove the back cover.
2. Connect the two-core cable to appropriate sockets in the regulator or the receiver.
3. In the case of EU-T-4.2. check if the current communication channel selected in the regulator is the same as in the receiver. 35 is the default communication channel in all devices.
If there is a conflict with other devices using radio communication, it is necessary to select a different channel.

VII. HOW TO USE THE REGULATOR

1. PRINCIPLE OF OPERATION

The EU-T-4.1/EU-T-4.2 room regulator is designed to maintain the pre-set room temperature by sending a signal to the heating device (contact opening) when the pre- set room temperature has been reached. After receiving such a signal, the heating device is disabled (if it is connected to a CH boiler controller, the CH boiler switches to sustain mode after receiving the signal).

2. OPERATION MODES

The room regulator may operate in one of the following operation modes:

- **Day/night mode**

In this mode the pre-set temperature value depends on the current time of the day. The user may set different temperature values for the daytime and nighttime (comfort temperature and economical temperature) as well as define the exact time of entering day mode and night mode.

In order to activate this mode, press one of the buttons \checkmark/\wedge until *day/night mode* icon appears on the main screen.

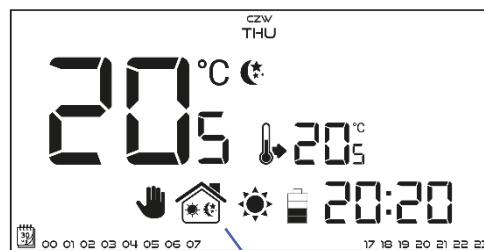

Weekly control

This mode enables the user to define the time when the pre-set comfort temperature and the pre-set economical temperature will apply. The user may set 9 different programs divided into three groups:

- **PROGRAMS 1÷3** – daily temperature values are set for all days of the week;
- **PROGRAMS 4÷6** – daily temperature values are set separately for the weekdays (Monday-Friday) and for the weekend (Saturday-Sunday);
- **PROGRAMS 7÷9** – daily temperature values are set for each day of the week separately.

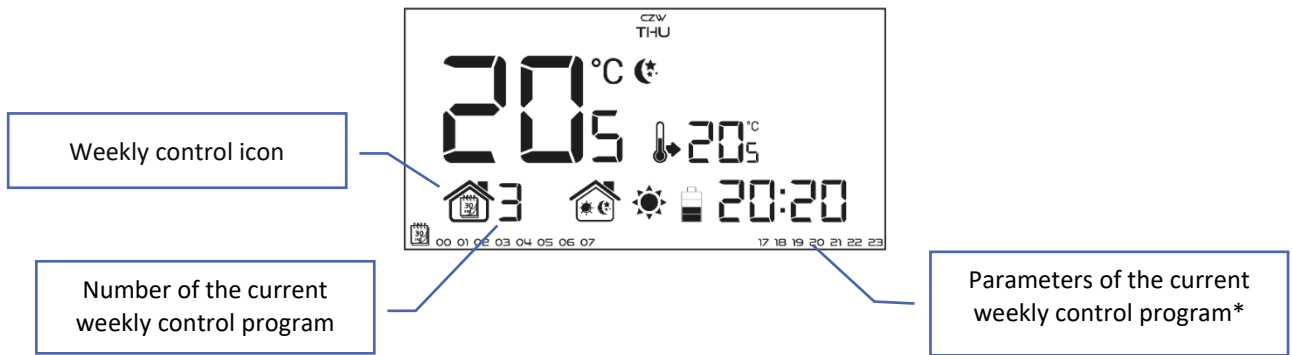

* The display shows the hours when the comfort temperature applies. In the remaining time period economical temperature applies.

In order to activate this mode, press one of the buttons ∇/\wedge until a weekly control icon appears on the main screen.

• **Manual mode**

In this mode the pre-set temperature is adjusted manually from the main screen view with the use of plus/minus buttons (+ -). Manual mode is activated automatically when one of these buttons is pressed. Once the manual mode is activated, the previous operation mode enters *sleep mode* until the next pre-programmed temperature change. Manual mode may be deactivated by pressing one of these buttons: \wedge/∇

Example 1 – manual mode activation in Day/night mode

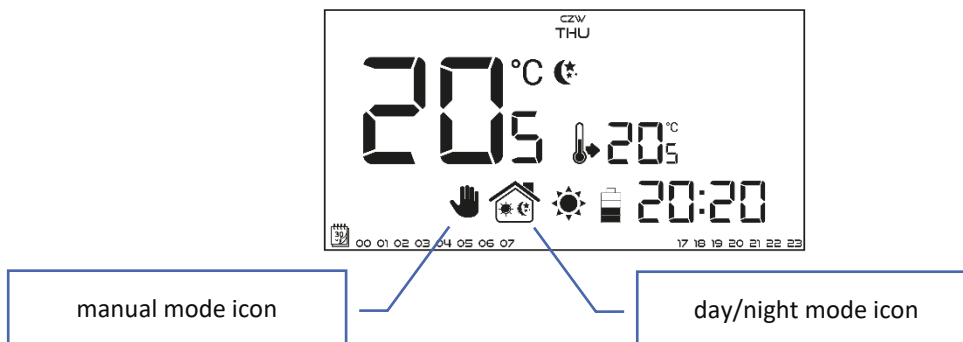

When *Day/night mode* is active, the user changes the pre-set temperature by pressing plus/minus button (+ -), which automatically activates manual mode. The controller returns to Day/night mode when daytime changes into nighttime (or the other way round) or when the user presses one of the buttons: ∇/\wedge .

Example 2 - manual mode activation in Weekly control mode

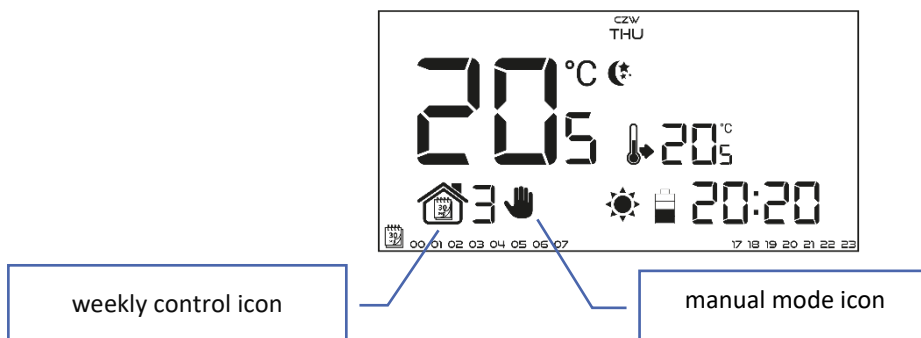

When *Weekly control mode* is active, the user changes the pre-set temperature by pressing plus/minus button (+ -), which automatically activates manual mode. The controller returns to *Weekly control mode* when, according to the weekly schedule, daytime changes into nighttime (or the other way round) or when the user presses one of the button ∇

3. MAIN SCREEN VIEW AND DESCRIPTION

The user operates the device using buttons. While one parameter is being edited, the remaining icons are not displayed..

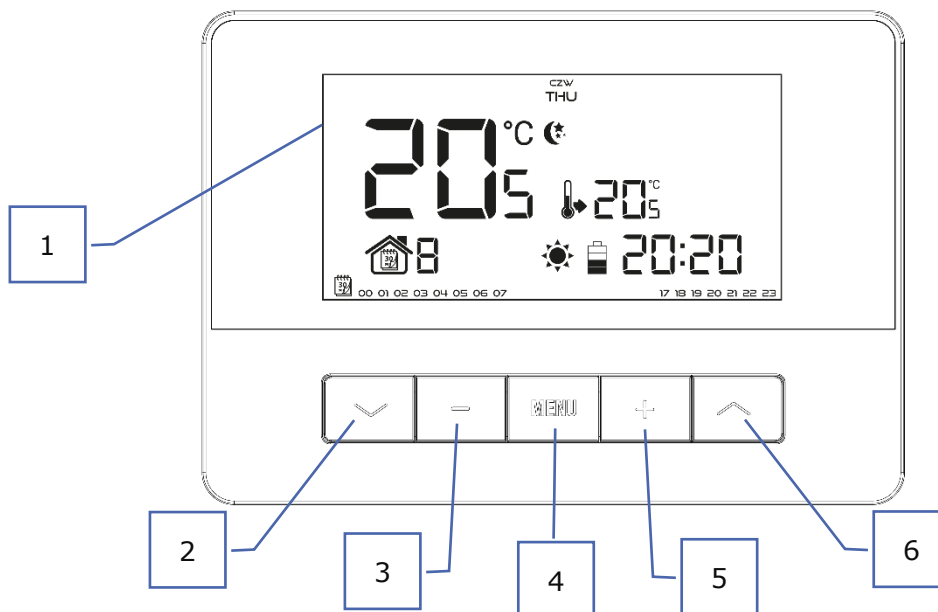



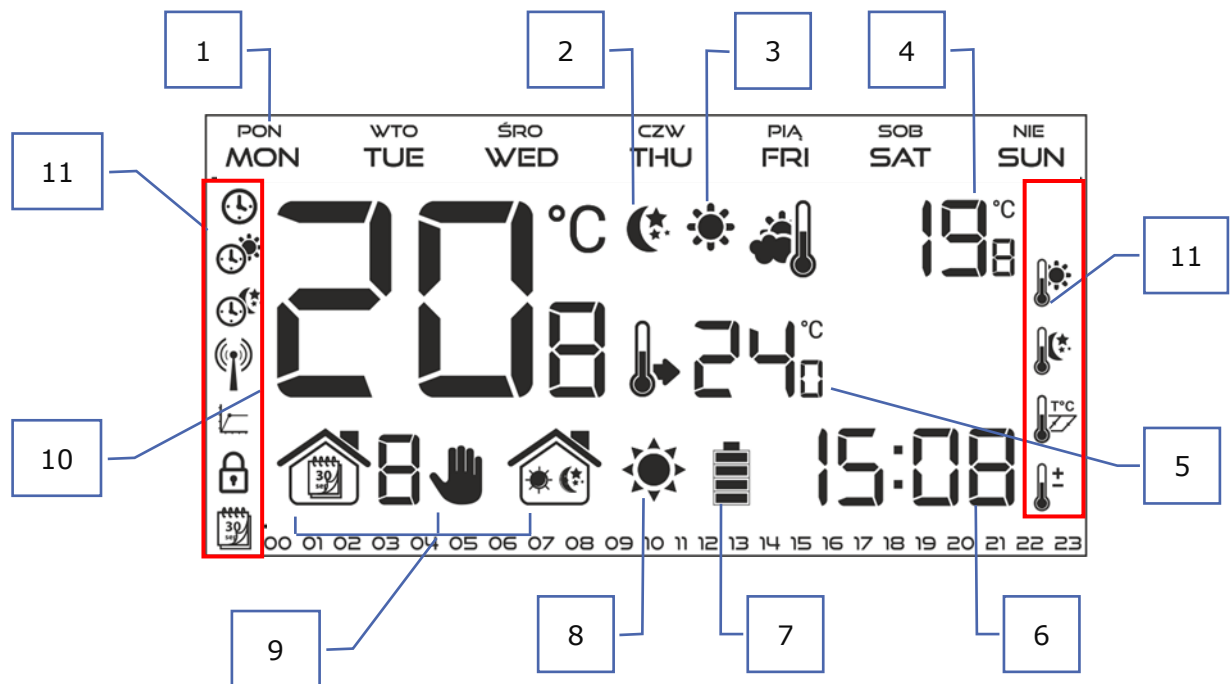







1. Display
2. ▼ - in the main screen view, use this button to activate weekly control mode. In the controller menu, use this button to switch between functions.
3. Minus button (-) – in the main screen view - press this button to switch to manual mode and decrease the pre-set temperature value. In the controller menu, use this button to change parameter settings, enter the service code etc.
4. MENU – hold this button to enter the controller menu. While editing parameters, press and hold this button to confirm the changes and return to the main screen view.
5. Plus button (+) – in the main screen view - press this button to switch to manual mode and increase the pre-set temperature value. In the controller menu, use this button to change parameter settings, enter the service code etc.
6. ▲ - in the main screen view, use this button to activate day/night mode. In the controller menu, use this button to switch between functions.





1. Day of the week
2. An icon informing about current economical temperature (resulting from weekly control or day/night mode settings).
3. An icon informing about current comfort temperature (resulting from weekly control or day/night mode settings).
4. Outside temperature – in the case of wireless version (EU-T-4.2), after an external temperature sensor has been registered.
5. Pre-set room temperature
6. Time
7. Battery level
8. An icon informing about room cooling/heating. The animation differs depending on the selected operation mode:
 - Heating mode – the icon flashes when the pre-set temperature has not been reached; it is steady when the pre-set temperature has been reached.
 - Cooling mode – the icon rotates when the temperature is above the pre-set value; it is steady when the pre-set temperature has been reached.
9. Current operation mode:
 - a. Weekly
 - b. Manual
 - c. Day/night
10. Current room temperature
11. Parameter icons (see: a table below)

USER MANUAL

Parameter icons:			
	Clock settings		Weekly control settings
	Day from...		Comfort temperature
	Night from...		Economical temperature
	Channel selection		Hysteresis
	Optimum start / heating/cooling mode selection (in service menu)		Temperature sensor calibration
	Service menu		

4. CONTROLLER FUNCTIONS

The user navigates the menu structure using all the buttons. In order to edit particular parameters, press and hold MENU. Next, press  to view the controller functions – the edited parameter is flashing whereas the remaining parameters are not displayed. Use plus and minus buttons (+ -) to change the parameter settings. Press  to confirm the changes and move on to edit the next parameter or press and  to confirm the changes and return to the previous parameter or press and hold MENU to confirm and return to the main screen view - apart from editing weekly control settings and channel selection.

4.1. MAIN MENU

MENU

- Day of the week
- Clock
- Day from...
- Night from...
- Optimum start
- Service menu
- Weekly program
- Pre-set comfort temperature
- Pre-set economical temperature
- Hysteresis
- Calibration

4.2. DAY OF THE WEEK

After entering the main menu, all icons which are not connected with the parameter which is being edited are not displayed. The first parameter is day of the week. Press + or - until the current day of the week appears on the screen. Press  to confirm and move on to the next parameter or press and hold MENU to confirm and return to the main screen view.

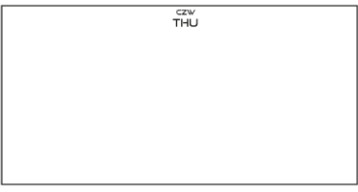

4.3. CLOCK

In order to set current time, enter the menu and press \checkmark or \wedge until time setting screen appears on the screen.

By pressing + or - set the hour and minutes. Press \checkmark to confirm.

Press \checkmark to confirm and move on to the next parameter or press and hold MENU to confirm and return to the main screen view.



4.4. DAY FROM...

This function enables the user to define the exact time of entering the day mode. When Day/night mode is active, comfort temperature applies at daytime.

To configure this parameter press \checkmark or \wedge until *Day from...* setting screen appears.

By pressing + or - set the hour and minute of day mode activation.

Press \checkmark to confirm and move on to the next parameter or press and hold MENU to confirm and return to the main screen view.



4.5. NIGHT FROM...

This function enables the user to define the exact time of entering the night mode. When Day/night mode is active, economical temperature applies at nighttime.

To configure this parameter press \checkmark or \wedge until *Night from...* setting screen appears.

By pressing + or - set the hour and minute of night mode activation.

Press \checkmark to confirm and move on to the next parameter or press and hold MENU to confirm and return to the main screen view.



4.6. OPTIMUM START

Optimum start is an intelligent system controlling the heating/cooling process. It involves constant monitoring of the heating/cooling system efficiency and using the information to activate the heating/cooling process in advance in order to reach the pre-set temperatures.

The system requires no user intervention. It precisely reacts to any changes that affect the efficiency of the heating system. If, for example, some changes have been introduced to the heating system and the house heats up faster than before, the Optimum start system will recognize the changes at the next pre-programmed temperature change (from comfort to economical) and in the next cycle the heating system activation will be adequately delayed, reducing the time needed to reach the desired temperature.

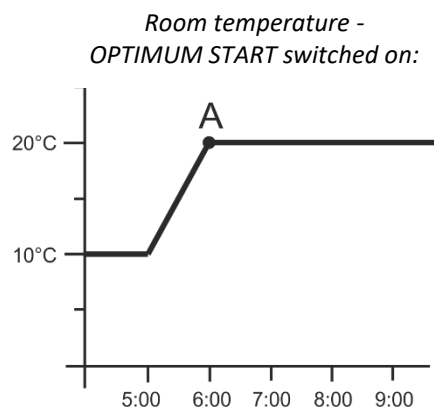
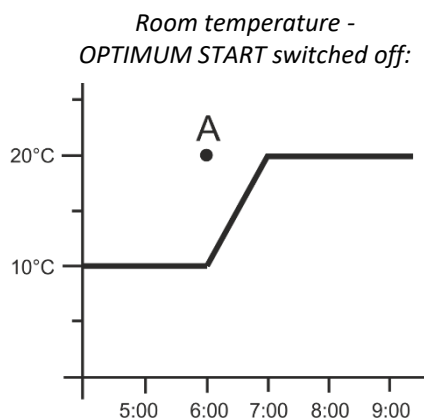

A – pre-programmed change from economical temperature to comfort temperature

Activating this function means that at the time of pre-programmed change of the pre-set temperature from comfort to economical or the other way round, the current room temperature is close to the desired value.

USER MANUAL

In order to configure this parameter, press one of the buttons \checkmark/\wedge until *Optimum start* setting panel appears on the screen.

Use + or - to activate or deactivate *Optimum start* function (ON/OFF). Press \checkmark to confirm and move on to edit the next parameter or press and hold MENU to confirm and return to the main screen view



4.7. SERVICE MENU



Certain functions in the controller service menu are secured with a code. In order to adjust their parameters, one of the buttons \checkmark/\wedge until *Service menu* settings appear on the screen.

To view the service menu it is necessary to enter the code – 215. Use + or – to select the first digit (2) and press MENU to confirm. Follow the same steps selecting the remaining two digits.



- **Heating/cooling mode**

This function enables the user to select the room regulator operation mode:

-  controlling the cooling system
-  controlling the heating system

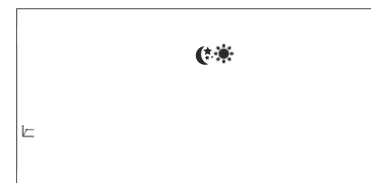

Press + or - to select desired type of system. Press \checkmark to confirm and move on to edit another parameter in the service menu or press and hold MENU to confirm to return to the main screen view.

- **Channel selection (option available only for EU-T-4.2)**

The EU-T-4.2 regulator communicates with the heating device or the CH boiler controller via a receiver using a radio signal. For the communication to take place it is necessary to select the same channel in both the controller and the receiver (and also in the external sensor if it is used). Channel 35 is the default communication channel in all devices. The channel should be changed only if the current channel is used by other devices.



In order to change, press one of the buttons \checkmark/\wedge until the channel change screen appears on the screen. Use + and - to select the channel. Press \checkmark to confirm and move on to the next parameter or press and hold MENU to confirm and return to the main screen view.

4.8. WEEKLY PROGRAM

This function is used to change the current weekly control program and edit the weekly programs.

- **How to change weekly program number**

When weekly control is enabled (see: VII.2. *Operation modes*) the current program is activated. In order to select the current program number, enter the menu and press one of the buttons \checkmark or \wedge until weekly program setting screen opens up.

By pressing and holding MENU button the user opens up the program selection screen. Each time the user holds the MENU button, the program number changes. When the desired number appears on the screen, press MENU – the controller returns to the main screen view and the selected program number is set.



weekly program number

- **How to configure particular weekly programs**

Weekly program allows the user to define the time when comfort temperature and economical temperature will apply. Depending on the program number, the user may set daily temperature values for all days of the week (programs 1÷3), for weekdays and the weekend separately (programs 4÷6) and for each day of the week separately (programs 7÷9).

In order to select the current program number, enter the menu and press one of the buttons **▼** or **▲** until weekly program setting screen opens up.



STEP 1 - CHOOSE THE PROGRAM TO BE EDITED

By pressing and holding MENU button the user opens up the program editing screen. Each time the user holds the MENU button, the program number changes. When the desired number appears on the screen, the user may start editing its parameters.

weekly program number

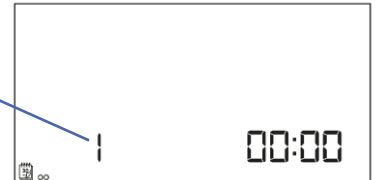

STEP 2 - SELECT DAYS OF THE WEEK

If the user wants to edit programs 1÷3, there is no possibility of selecting particular days of the week as the setting applies to each day.

If the user wants to edit programs 4÷6, it is possible to edit the settings for weekdays and the **weekend** separately. Press buttons **▼** or **▲** briefly in order to select.

If the user wants to edit programs 7÷9, it is possible to edit the settings for each day separately. Press buttons **▼** or **▲** briefly in order to select a day.

editing parameters for Monday



In order to choose the days when a given program should apply, use of the buttons **▼** **▲**.

STEP 3 - ASSIGNING COMFORT OR ECONOMICAL TEMPERATURE TO PARTICULAR HOURS

An hour which is being edited is displayed on the controller screen. In order to assign comfort temperature, press the plus button (+). In order to select economical temperature, press the minus button (-).

The parameters of the weekly program are displayed at the bottom of the screen: **hours to which comfort temperature has been assigned are displayed whereas hours to which economical temperature has been assigned are not displayed.**

edited hour

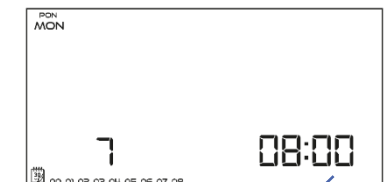

Example:

The following screenshot presents daily settings of program no. 7 for Monday

- 24⁰⁰-01⁵⁹- economical temperature
- 02⁰⁰-06⁵⁹- comfort temperature
- 07⁰⁰-14⁵⁹- economical temperature
- 15⁰⁰-21⁵⁹- comfort temperature
- 22⁰⁰-00⁵⁹- economical temperature

editing weekdays parameters

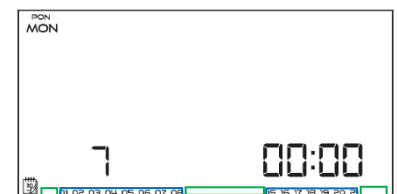

NOTE

When the user finishes the editing process by pressing MENU button, the controller returns to the main screen view and this program is selected as the current program.

USER MANUAL

4.9. PRE-SET COMFORT TEMPERATURE

Pre-set comfort temperature is used in weekly control mode and day/night mode. Press one of the buttons \checkmark/\wedge until the comfort temperature change screen appears on the screen.

Press + or - to set the desired temperature.

Press \checkmark to confirm and move on to the next parameter or press and hold MENU to confirm and return to the main screen view.



4.10. PRE-SET ECONOMICAL TEMPERATURE

Pre-set economical temperature is used in weekly control mode and day/night mode. Press one of the buttons \checkmark/\wedge until the economical temperature change screen appears on the screen.

Press + or - to set the desired temperature.

Press \checkmark to confirm and move on to the next parameter or press and hold MENU to confirm and return to the main screen view.



4.11. PRE-SET TEMPERATURE HYSTERESIS

Room temperature hysteresis defines the tolerance of the pre-set temperature at which cooling or heating is activated (within the range of 0,2 ÷ 4°).

In order to set the hysteresis, press one of the buttons \checkmark/\wedge until the hysteresis settings appear on the screen.

Use + or - to set the desired hysteresis value. Press \checkmark to confirm and move on to the next parameter or press and hold MENU to confirm and return to the main screen view.

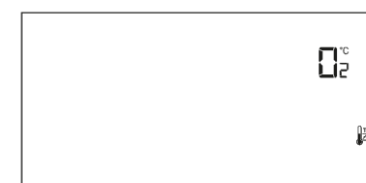

Example:

Pre-set temperature : 23°C

Hysteresis : 1°C

The room regulator reports that the temperature is too low only when the room temperature drops to 22 °C.

4.12. TEMPERATURE SENSOR CALIBRATION

It is performed when mounting the regulator or after it has been used for a long time, if the room temperature measured by the internal sensor differs from the actual temperature. Calibration setting range is from -10°C to +10°C with the accuracy of 0,1°C.

Press one of the buttons \checkmark/\wedge until the sensor calibration panel appears on the screen. Use + and - to define correction. Press \checkmark to confirm and move on to edit the next parameter or press and hold MENU to confirm and return to the main screen view.

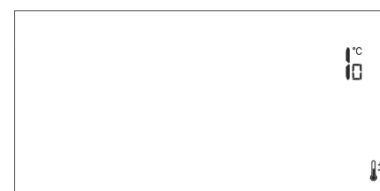

VIII. TECHNICAL DATA

	EU-T-4.1	EU-T-4.2
Power supply	2xAA, 1,5V batteries	2xAA, 1,5V batteries
Room temp. adjustment range	5°C ÷ 35°C	5°C ÷ 35°C
Potential-free cont. nom. out. load	230V AC / 0,5A (AC1) * 24V DC / 0,5A (DC1) **	-
Measurement error	± 0,5	± 0,5
Operation frequency	-	868MHz

	EU-MW-2 (EU-T-4.2)
Power supply	230V ± 10% / 50Hz
Operation temperature	5°C ÷ 50°C
Maximum power consumption	<1W
Potential-free cont. nom. out. load	230V AC / 0,5A (AC1) * 24V DC / 0,5A (DC1) **
Operation frequency	868MHz
Max. transmission power	25mW

* AC1 load category: single-phase, resistive or slightly inductive AC load.

** DC1 load category: direct current, resistive or slightly inductive load.

TECH CONTROLLERS

EU declaration of conformity

Hereby, we declare under our sole responsibility that **EU-T-4.1** manufactured by TECH STEROWNIKI II Sp. z o.o., headquartered in Wieprz Biała Droga 31, 34-122 Wieprz, is compliant with Directive **2014/35/EU** of the European Parliament and of the Council of 26 February 2014 on the harmonisation of the laws of Member States relating to **the making available on the market of electrical equipment designed for use within certain voltage limits** (EU OJ L 96, of 29.03.2014, p. 357), **Directive 2014/30/EU** of the European Parliament and of the Council of 26 February 2014 on the harmonisation of the laws of Member States relating to **electromagnetic compatibility** (EU OJ L 96 of 29.03.2014, p.79), Directive **2009/125/EC** establishing a framework for the setting of ecodesign requirements for energy-related products as well as the regulation by the MINISTRY OF ENTREPRENEURSHIP AND TECHNOLOGY of 24 June 2019 amending the regulation concerning the essential requirements as regards the restriction of the use of certain hazardous substances in electrical and electronic equipment, implementing provisions of Directive (EU) 2017/2102 of the European Parliament and of the Council of 15 November 2017 amending Directive 2011/65/EU on the restriction of the use of certain hazardous substances in electrical and electronic equipment (OJ L 305, 21.11.2017, p. 8).

For compliance assessment, harmonized standards were used:

PN-EN IEC 60730-2-9:2019-06, PN-EN 60730-1:2016-10, EN IEC 63000:2018 RoHS .

UE declaration of conformity

Hereby, we declare under our sole responsibility that **EU-T-4.2** manufactured by TECH STEROWNIKI II Sp. z o.o., headquartered in Wieprz Biała Droga 31, 34-122 Wieprz, is compliant with Directive **2014/53/EU** of the European parliament and of the Council of 16 April 2014 on the harmonisation of the laws of the Member States relating to the making available on the market of radio equipment, Directive **2009/125/EC** establishing a framework for the setting of ecodesign requirements for energy-related products as well as the regulation by the MINISTRY OF ENTREPRENEURSHIP AND TECHNOLOGY of 24 June 2019 amending the regulation concerning the essential requirements as regards the restriction of the use of certain hazardous substances in electrical and electronic equipment, implementing provisions of Directive (EU) 2017/2102 of the European Parliament and of the Council of 15 November 2017 amending Directive 2011/65/EU on the restriction of the use of certain hazardous substances in electrical and electronic equipment (OJ L 305, 21.11.2017, p. 8).

For compliance assessment, harmonized standards were used:

PN-EN IEC 60730-2-9 :2019-06 art. 3.1a Safety of use

PN-EN 62479:2011 art. 3.1 a Safety of use

ETSI EN 301 489-1 V2.2.3 (2019-11) art.3.1b Electromagnetic compatibility

ETSI EN 301 489-3 V2.1.1:2019-03 art.3.1 b Electromagnetic compatibility

ETSI EN 300 220-2 V3.2.1 (2018-06) art.3.2 Effective and coherent use of radio spectrum

ETSI EN 300 220-1 V3.1.1 (2017-02) art.3.2 Effective and coherent use of radio spectrum

EN IEC 63000:2018 RoHS

Wieprz, 28.05.2021

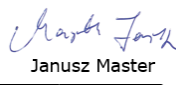
Paweł Jura

Janusz Master
Prezisi firmy

**TECH
TECH
CONTROLLERS**

Central headquarters:

ul. Biała Droga 31, 34-122 Wieprz

Service:

ul. Skotnica 120, 32-652 Bulowice

phone: **+48 33 875 93 80**

e-mail: **serwis@techsterowniki.pl**

www.tech-controllers.com