

TECH TECH CONTROLLERS

USER MANUAL

EU-WiFi X

EN

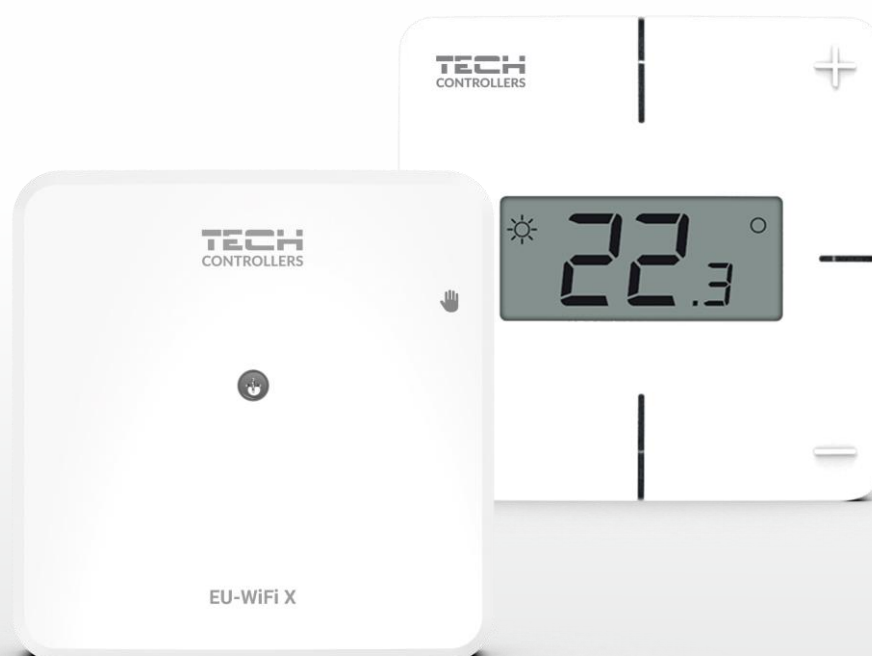

www.tech-controllers.com

TABLE OF CONTENTS

I.	Safety	4
II.	Device description	5
III.	Controller installation	7
IV.	First start-up	8
1.	Connecting the controller.....	8
2.	Internet connection configuration	8
3.	Work as a contact – Potential-free contact mode	9
4.	Manual mode	9
5.	Registration of the regulator and floor sensor	9
V.	Installation control in emodul.eu	10
1.	HOME tab	11
1.1.	Potential-free contact mode	11
1.2.	Zone operation mode	12
2.	Zones tab	16
3.	Menu tab	16
3.1.	Operation type.....	16
3.2.	Operating mode.....	16
3.3.	Zone	16
3.3.1.	Room sensor	16
3.3.2.	Floor heating.....	17
3.3.3.	Settings	17
3.4.	Heating - cooling.....	17
3.4.1.	Operating mode.....	17
3.5.	Protection - humidity.....	18
3.6.	Factory defaults	18
3.7.	Internet module.....	18
4.	Service menu	18
5.	Statistics tab	18
6.	Settings tab.....	19
VI.	Software update	20
VII.	Technical data	20

JG.17.12.2025

I. SAFETY

Before using the device for the first time the user should read the following regulations carefully. Not obeying the rules included in this manual may lead to personal injuries or controller damage. In order to avoid accidents and errors it should be ensured that every person using the device has familiarized themselves with the principle of operation as well as security functions of the controller. If the device is to be sold or put in a different place, make sure that the user's manual is stored with the device so that any potential user has access to essential information about the device. The manufacturer does not accept responsibility for any injuries or damage resulting from negligence; therefore, users are obliged to take the necessary safety measures listed in this manual to protect their lives and property.



WARNING

- **A live electrical device!** Make sure the regulator is disconnected from the mains before performing any activities involving the power supply (plugging cables, installing the device etc.).
- The device should be installed by a qualified electrician.
- The controller should not be operated by children.



WARNING

- Any use other than specified by the manufacturer is forbidden.
- Before and during the heating season, the controller should be checked for condition of its cables. The user should also check if the controller is properly mounted and clean it if dusty or dirty.

Changes in the products described in the manual may have been introduced subsequent to its completion on 11.08.2022. The manufacturer retains the right to introduce changes to the design and colours. The illustrations may include additional equipment. Print technology may result in differences in the colours shown.

We are committed to protecting the environment. Manufacturing electronic devices imposes an obligation of providing for environmentally safe disposal of used electronic components and devices. Hence, we have been entered into a register kept by the Inspection for Environmental Protection. The crossed-out bin symbol on a product means that the product may not be disposed of to household waste containers. Recycling of waste helps to protect the environment. The user is obliged to transfer their used equipment to a collection point where all electric and electronic components will be recycled.



II. DEVICE DESCRIPTION

EU-WiFi X is a module included with a wireless controller.

The device is designed to maintain the temperature of the room and floor at a constant level. Heating or cooling is switched on via a potential-free contact.

Thanks to the use of a WiFi module, you can control the operation of parameters using the emodul.eu application.

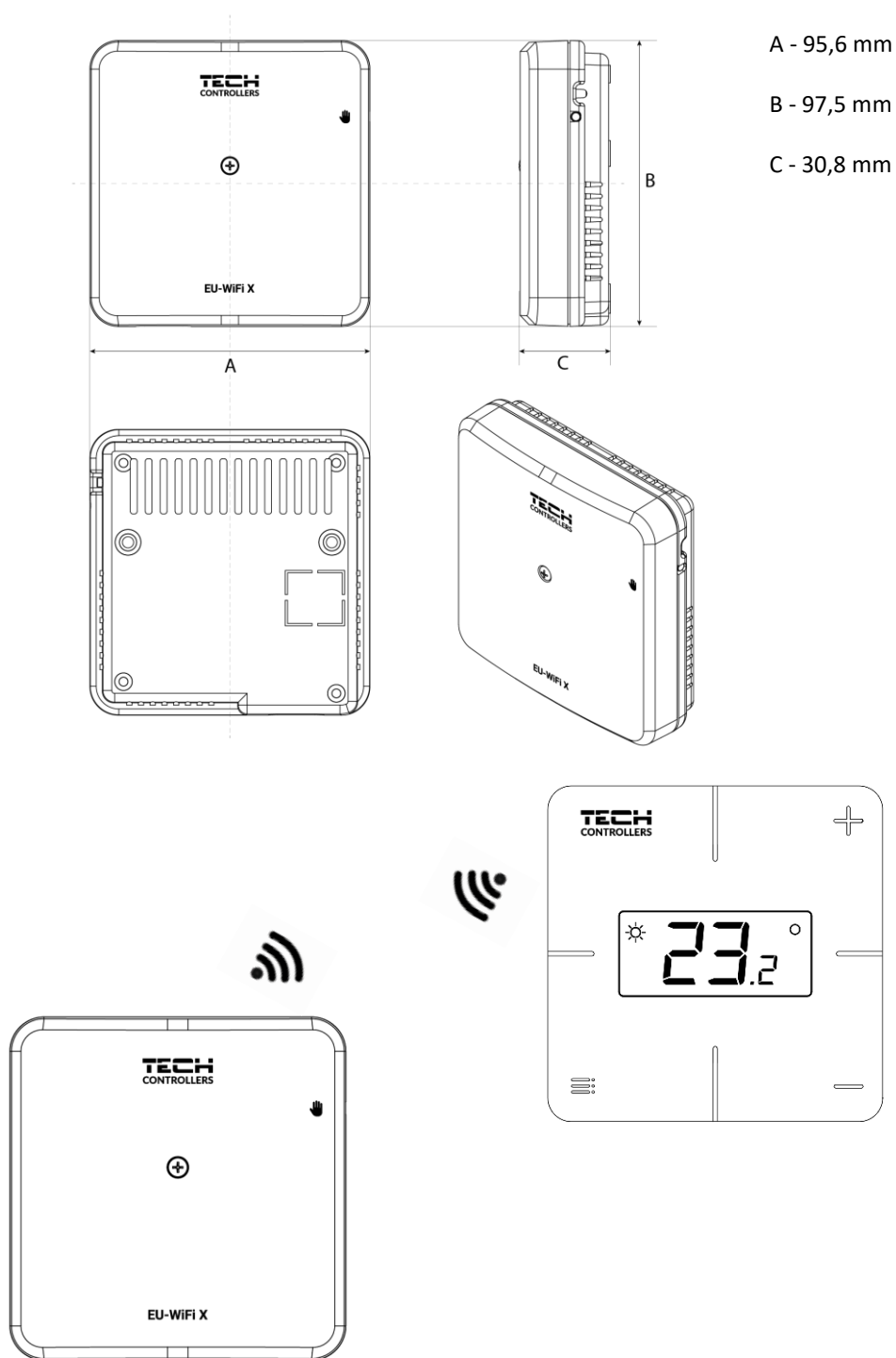

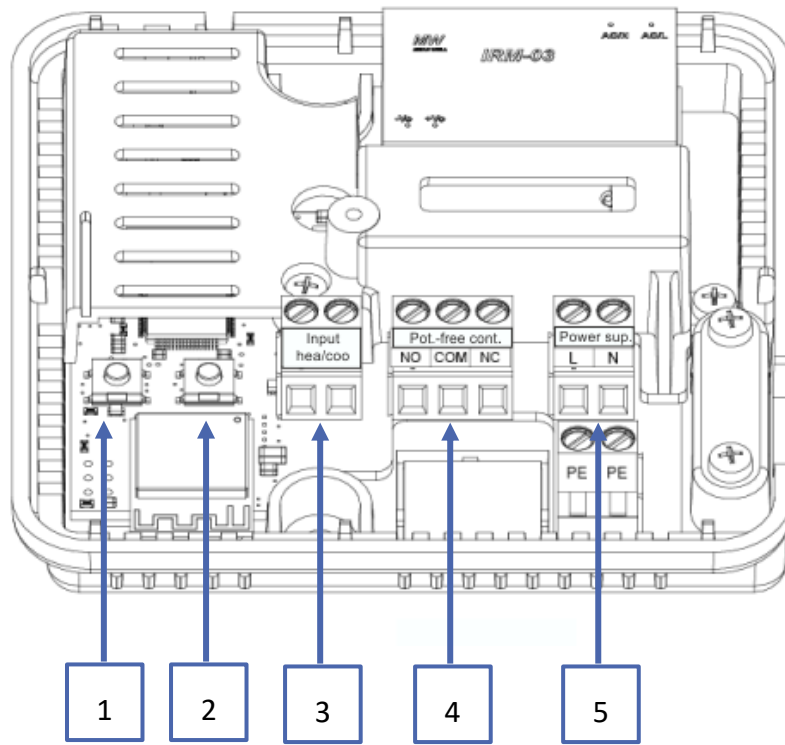

1. Module registration button
2. Registration button for the controller, floor sensor
3. Heating/cooling input
4. Potential-free contact
5. Power supply

III. CONTROLLER INSTALLATION

! WARNING

- The device should be installed by a qualified person.
- Risk of fatal electric shock from touching live connections. Before working on the controller switch off the power supply and prevent it from being accidentally switched on.

To connect the cables, remove the controller cover.

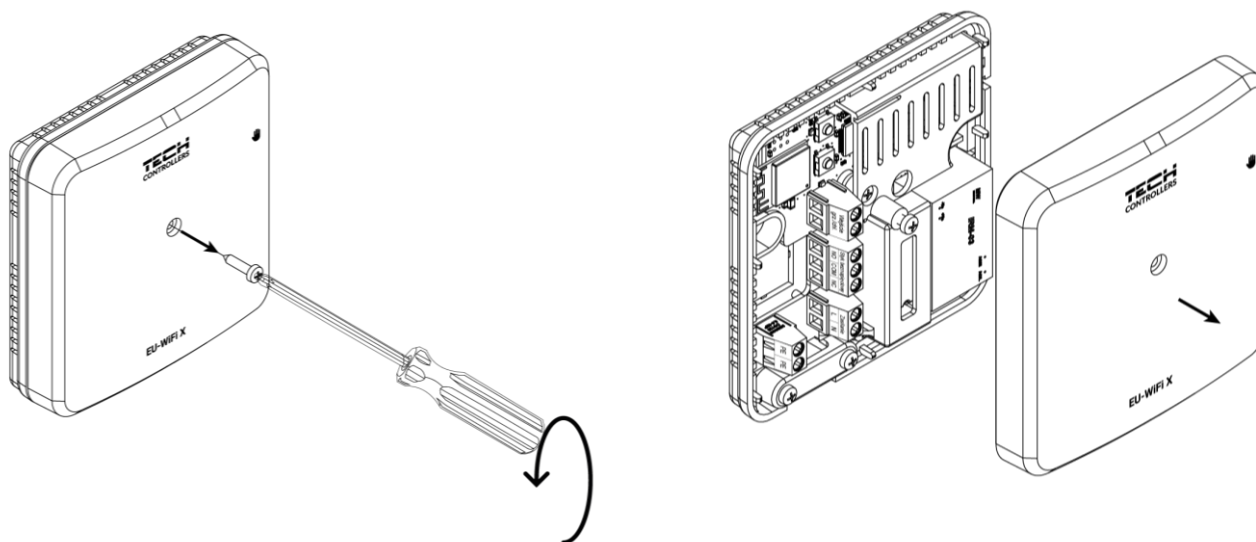

The cabling should be connected in accordance with the description on the connectors and the diagram.

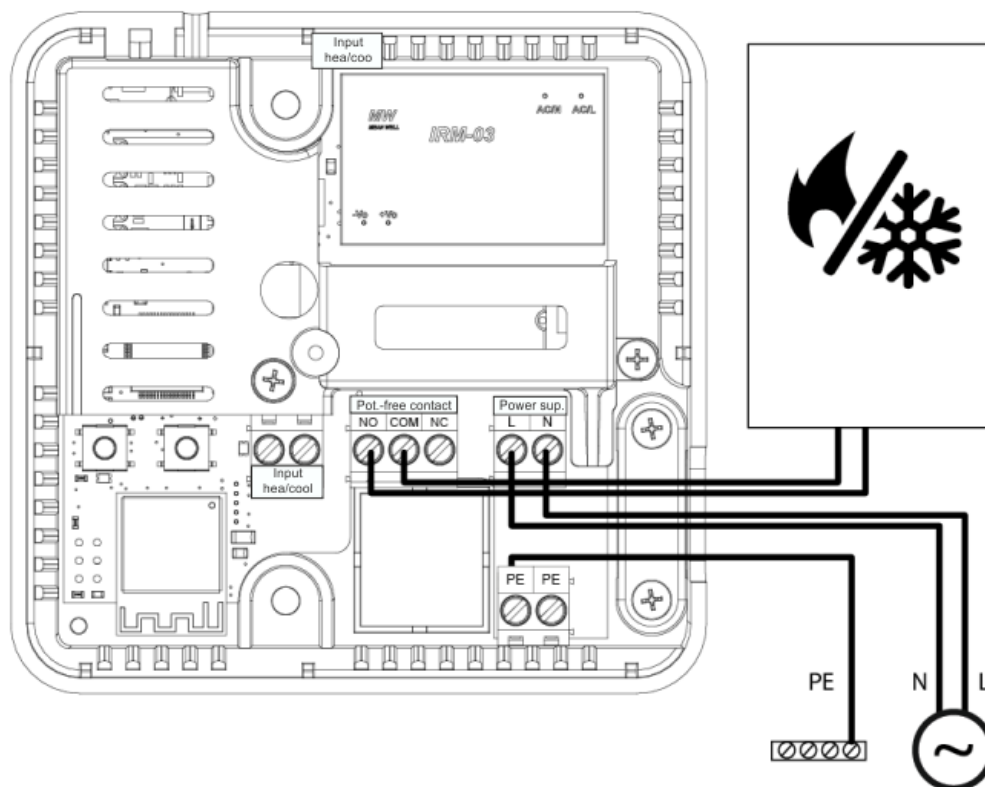

IV. FIRST START-UP



NOTE

It is recommended to check for new software updates for the module and controller.

For the controller to work properly, please follow the steps below when starting it for the first time:

1. Connecting the controller according to the diagram
2. Internet connection configuration
3. Work as a contact
4. Manual mode
5. Registration of the regulator and floor sensor

1. CONNECTING THE CONTROLLER

The controller should be connected according to the diagrams provided in this section „*Controller installation*“.

2. INTERNET CONNECTION CONFIGURATION

Thanks to the WiFi module, it is possible to control and edit parameter settings via the Internet. To do this, you need to configure a connection to a WiFi network.

- Press the web module registration button on the controller
- Turn on WiFi on your phone and search for networks (currently it's "TECH_XXXX")
- Select network "TECH_XXXX"
- In the open tab, select the WiFi network with the "WiFi network selection" option
- Connect to the network. If necessary, enter your password.
- Generate the code for registration on emodul using the "Module registration" option
- Create an account or log in to emodul.eu and register the module (see section "Installation control in emodul")

Required network settings

For the Internet module to work properly, it is necessary to connect the module to the network with a DHCP server and an open port 2000.

After connecting the Internet module to the network, go to the module settings menu (in the master controller).

If the network does not have a DHCP server, the Internet module should be configured by its administrator by entering appropriate parameters (DHCP, IP address, Gateway address, Subnet mask, DNS address).

1. Go to the Internet **module / WiFi** settings menu.
2. Select "ON".
3. Check if the "DHCP" option is selected.
4. Go to "WIFI network selection"
5. Select your WIFI network and enter the password.
6. Wait for a while (approx. 1 min) and check if an IP address has been assigned. Go to the "IP address" tab and check if the value is different from 0.0.0.0 / -.-.-.-.
 - a) If the value is still 0.0.0.0 / -.-.-.-, check the network settings or the Ethernet connection between the Internet module and the device.
7. After the IP address has been assigned, start the module registration in order to generate a code which must be assigned to the account in the application.

3. WORK AS A CONTACT – POTENTIAL-FREE CONTACT MODE

By default, the controller operating mode is “set to contact”. If it is otherwise, and the user needs to input change, please select this type of operation in the Menu tab of the emodul.eu application, and select the "Enabled" option.

After changing the type of operation to the Zone and after registering the room controller, the module controls the contact based on the data generated through the temperature sensor.

The operation of the potential-free contact is described in the chapter *Potential-free contact mode*, p. 11.

4. MANUAL MODE

The controller has a manual mode function. To enter this mode, **briefly press** the manual button. This will cause the controller to enter in 15-min. manual operation, which is signaled by the manual operation diode flashing. To exit manual operation, **hold** down the manual operation button.

Holding the manual mode button will enter the permanent manual mode mode, which is indicated by the manual mode diode with constant light.

A short press on the manual button changes the output status of the potential-free contact.

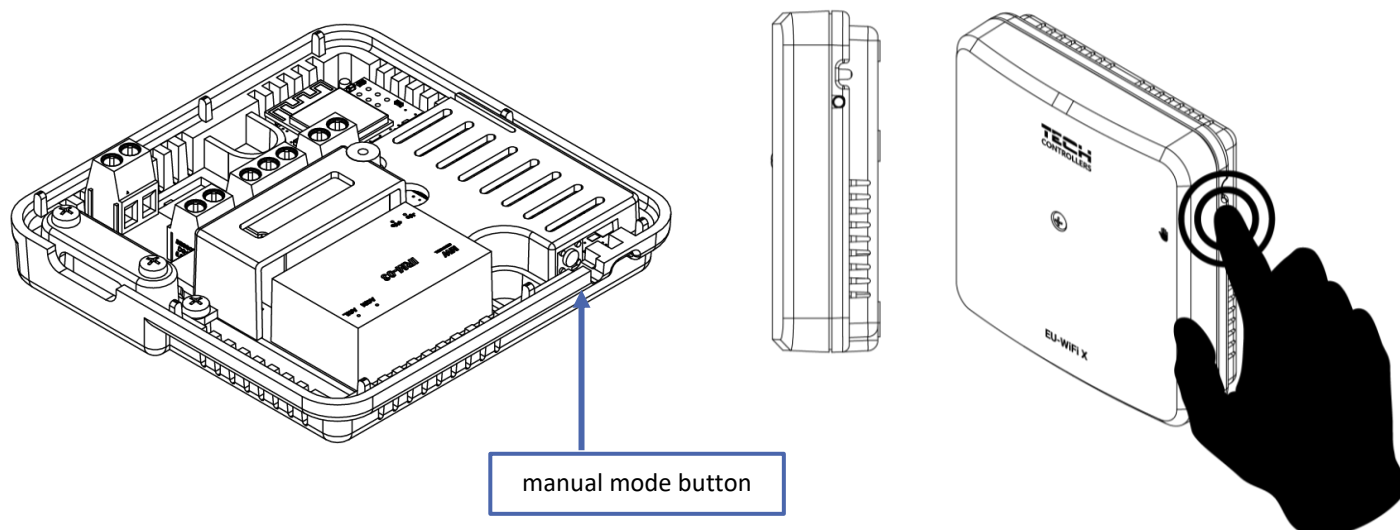

5. REGISTRATION OF THE REGULATOR AND FLOOR SENSOR

A wireless regulator is included in the set. To pair the regulator with the module, remove the module cover and press the registration button on the module and the regulator. The LED on the main controller flashes while waiting for registration. A successful registration process will be confirmed by the LED flashing 5 times.

NOTE!

To re-register the sensor, first delete its current status as shown in the Menu. If the LED is continuously on (not flashing) after pressing the registration button in the EU-WiFi X module, this means that the sensor has not been deleted!

To register a wireless floor sensor, activate the registration by briefly pressing the registration button on the module and on the regulator twice. The LED on the main controller will flash twice while waiting for registration. A successful registration process will be confirmed by the LED flashing 5 times.

NOTE!

The floor sensor can be registered as a room sensor by pressing the registration button once on the module and twice on the controller.

V. INSTALLATION CONTROL IN EMODUL.EU

The web application at <https://emodul.eu> offers multiple tools for controlling your heating system. In order to take full advantage of the technology, create your own account:

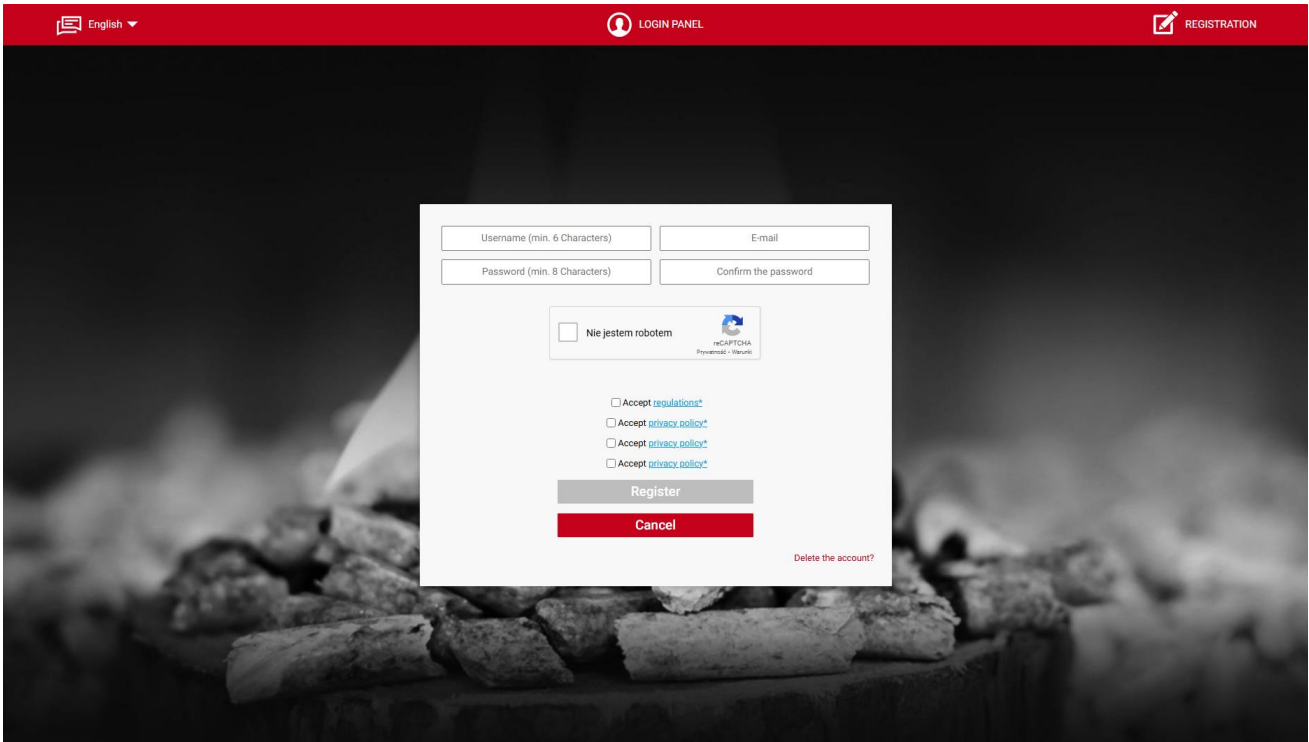

The screenshot shows the registration form on the emodul.eu website. The form is centered on a dark background with a blurred image of a fireplace. The form fields include: Username (min. 6 Characters), Email, Password (min. 8 Characters), and Confirm the password. Below these fields is a checkbox for "Nie jestem robotem" (I am not a robot) with a reCAPTCHA logo. There are also four checkboxes for accepting regulations and privacy policies. At the bottom of the form are "Register" and "Cancel" buttons, and a small link for "Delete the account?". The website header is red and contains "English", "LOGIN PANEL", and "REGISTRATION" links.

Registration a new account at <https://emodul.eu>

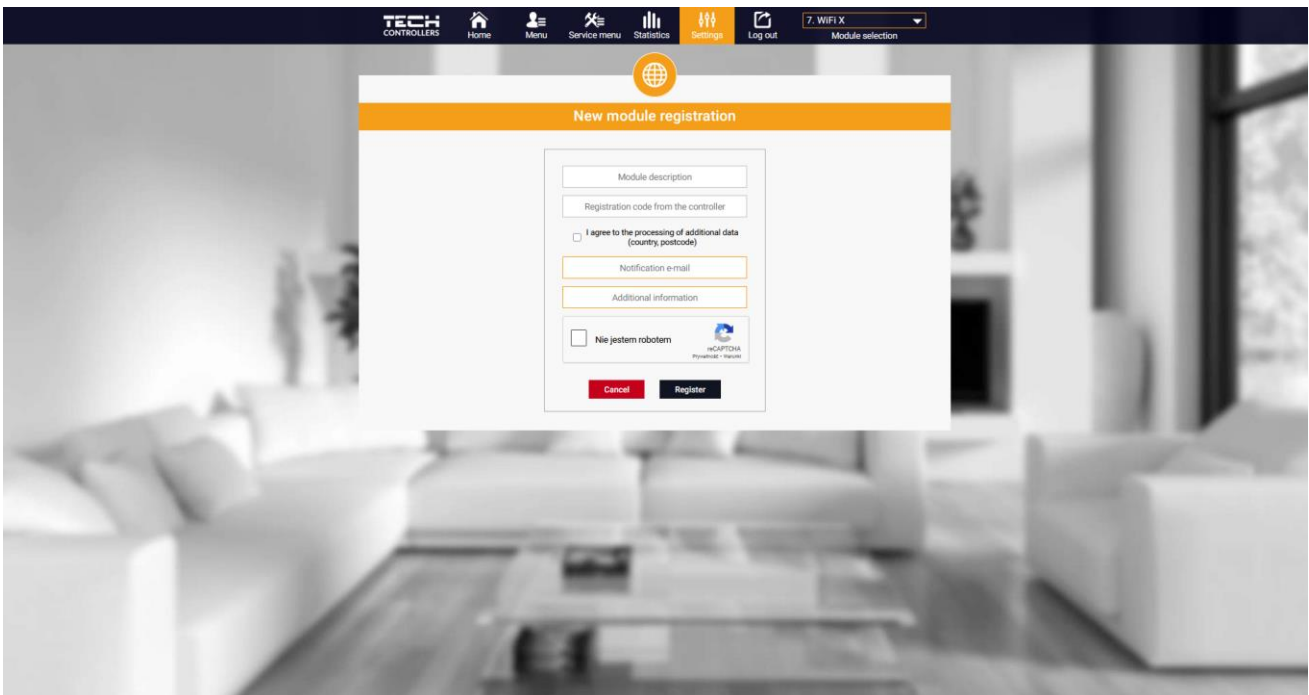

The screenshot shows the "New module registration" form on the emodul.eu website. The form is centered on a blurred background of a modern living room. The form fields include: Module description, Registration code from the controller, a checkbox for "I agree to the processing of additional data (country, postcode)", Notification e-mail, and Additional information. Below these fields is a checkbox for "Nie jestem robotem" (I am not a robot) with a reCAPTCHA logo. At the bottom of the form are "Cancel" and "Register" buttons. The website header is dark blue and contains "TECH CONTROLLERS", "Home", "Menu", "Service menu", "Statistics", "Settings", "Log out", and "7. WIFI X" with a "Module selection" dropdown menu.

Registration a new module

Once logged in, go to the Settings tab and select Register module. Next, enter the code generated by the controller (we generate the code on the phone in the "Configuration portal" tab in the "Module registration" option). The module may be assigned a name (in the field labelled *Module description*).

1. HOME TAB

Home tab displays the main screen with tiles illustrating the current status of particular heating system devices.

1.1. POTENTIAL-FREE CONTACT MODE

In order for the controller to operate in the contact mode, this type of operation must be activated in the Menu and the "Enabled" option must be selected. Only then will the individual parameters for the contact operation be displayed!

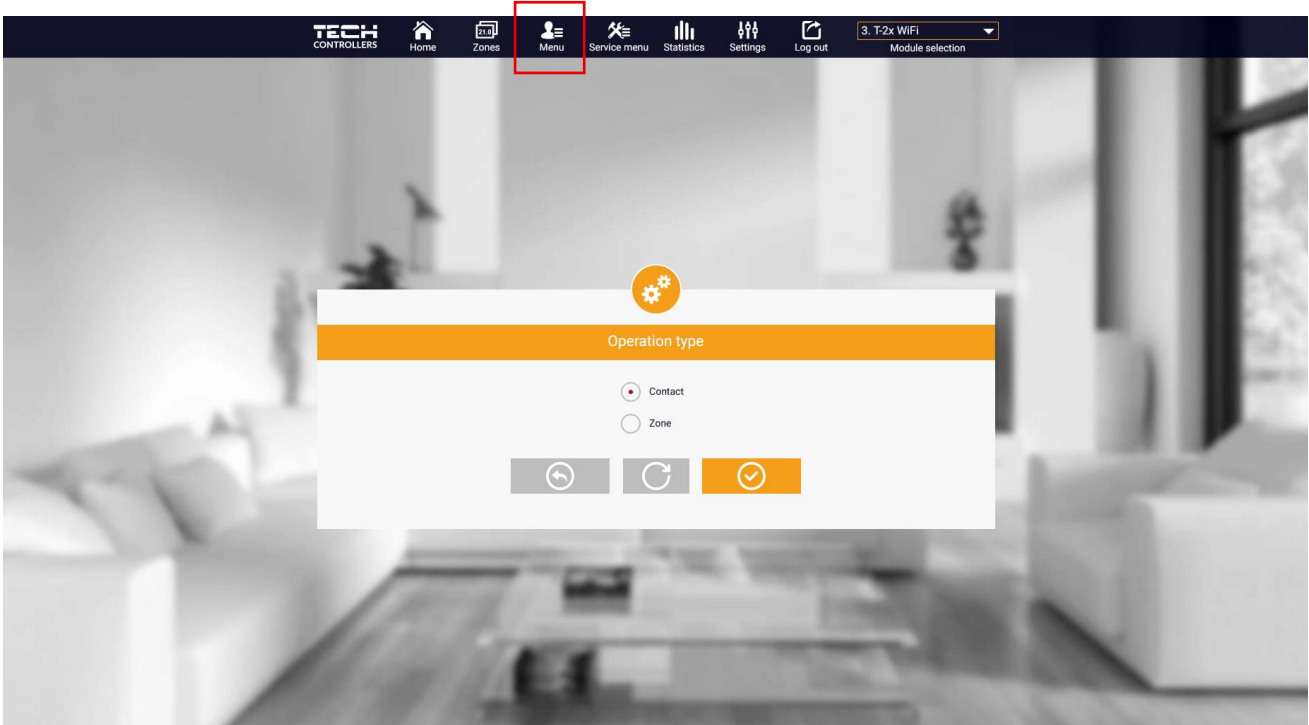

Operating mode selection screen

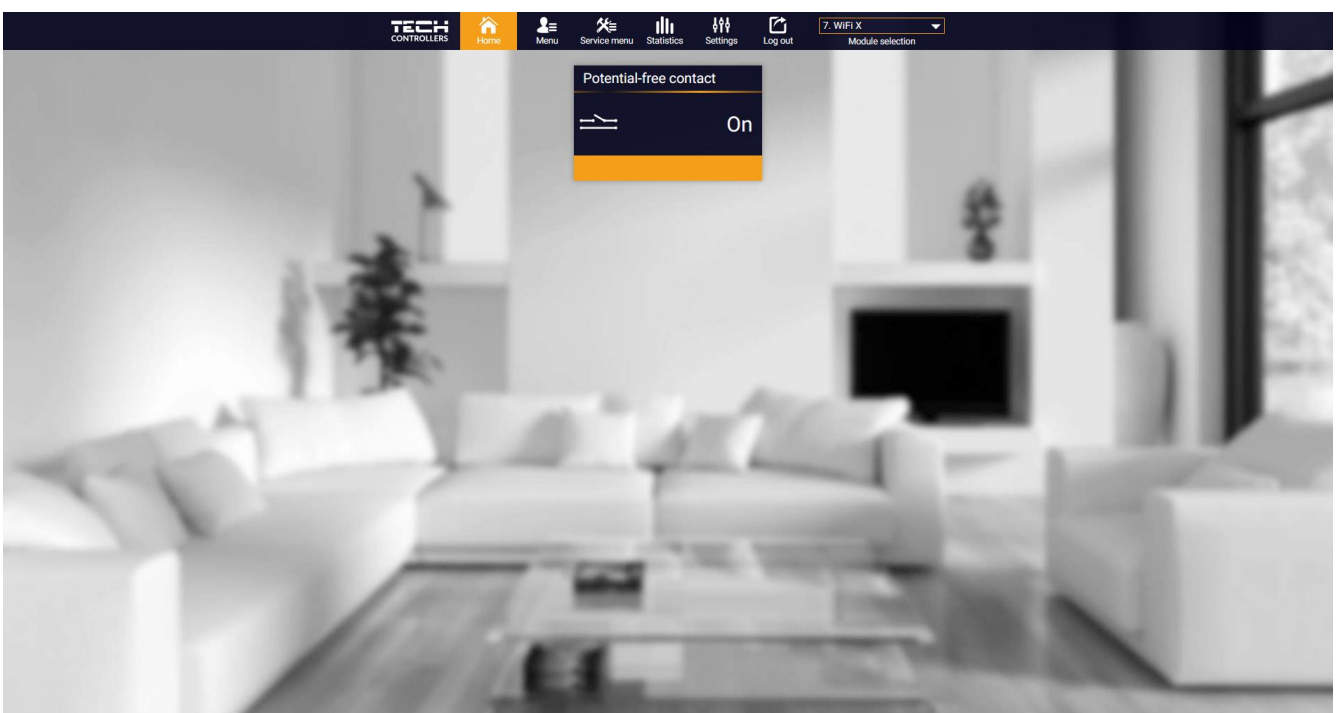

- **OFF/ON** – disables/enables the contact from the following modes:
- **Operating mode**
 - **Manual operation** – control of the contact for permanent operation through immediate input (see item: Manual operation)
 - **Schedule** – control of the contact by the schedule set for a particular day of the week.
- **Schedule** – set contact operation schedule.
- **Operation type**
 - **Contact** – the controller controls the heating/cooling device based upon the settings, e.g. schedule
 - **Zone** – the controller controls the heating/cooling device based upon data from the sensor registered in the zone.
- **Two-state input** – if the function is ON, the contact operates according to the previously selected mode (manual operation or schedule) provided that the "Heat/Cool" input is short-circuited.
- **Internet module** – it is possible to connect to the WiFi module in a web browser. However, the device must be connected to the same network as the controller. In this case, enter the displayed IP address in the web browser to access the parameters of the Configuration Portal (e.g. for downloading the current version of the software).

1.2. ZONE OPERATION MODE

Select the "Zones" mode and register the controller. A tile with the parameters of a given zone will appear on the main screen.



NOTE!

Switching the controller from "Zone" to "Contact" mode automatically de-registers the controller!

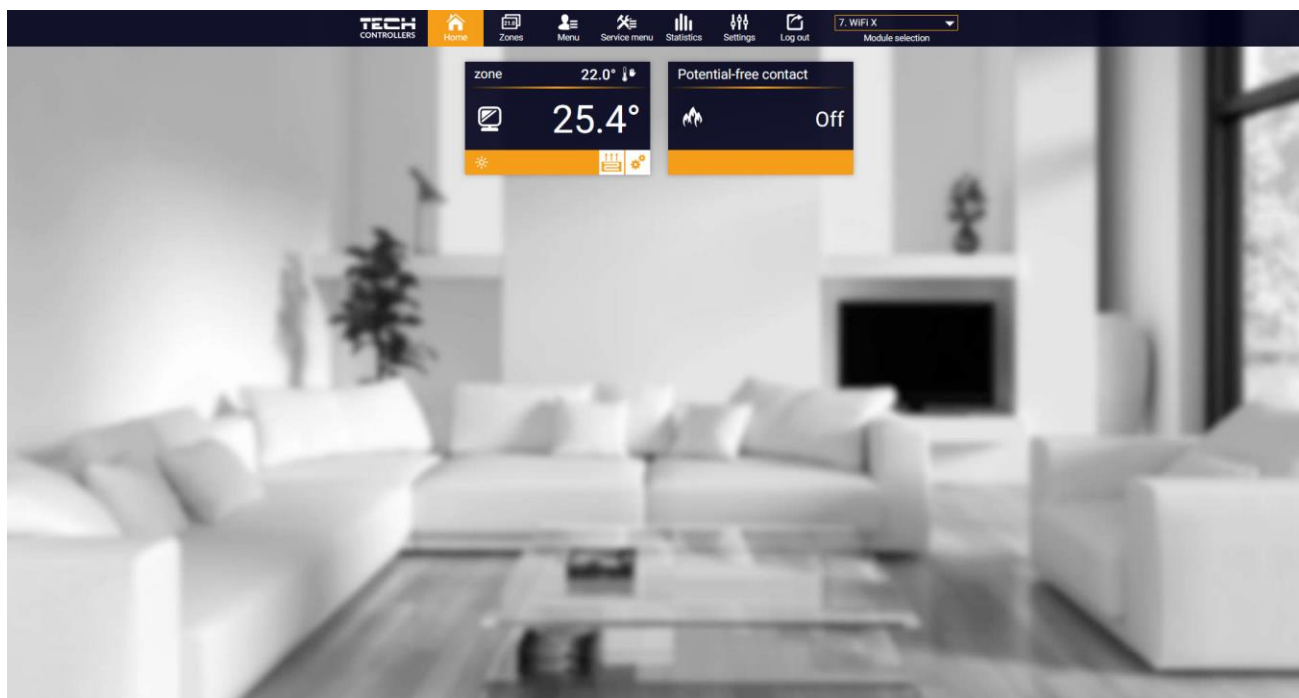

HOME tab

Tap on the tile corresponding to a given zone to edit its pre-set temperature.

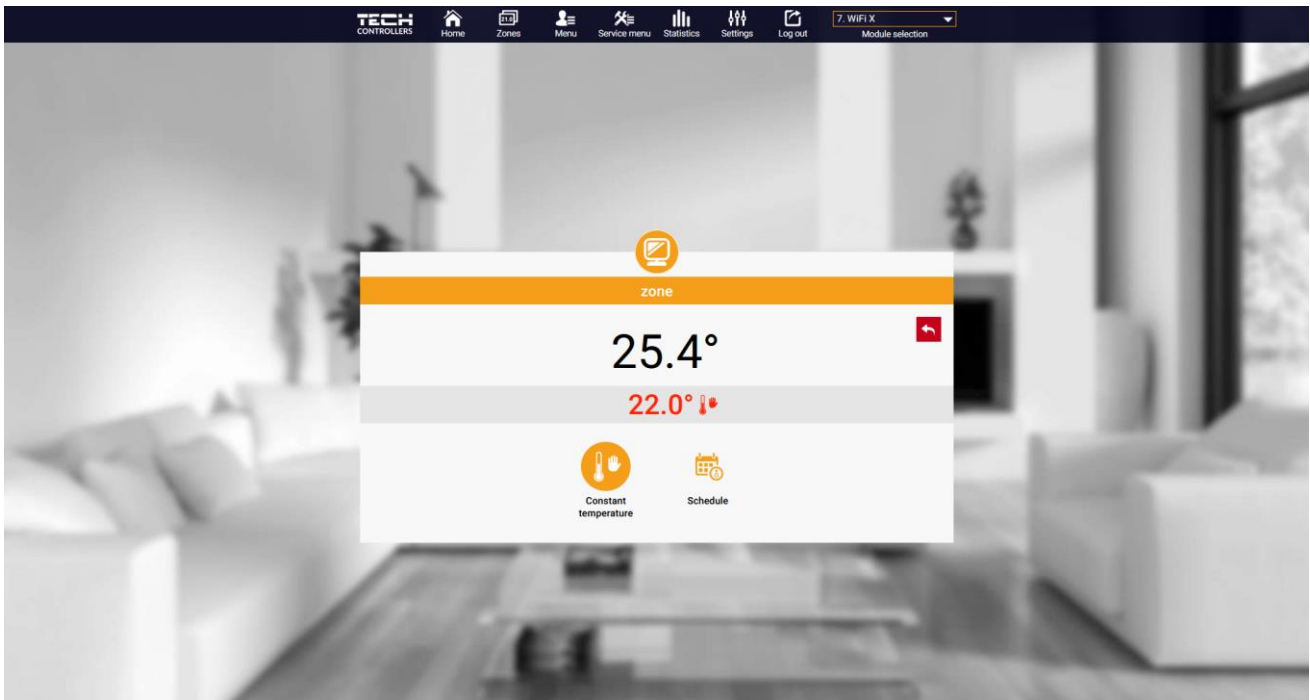

Editing the pre-set temperature

The upper value is the current zone temperature whereas the bottom value is the pre-set temperature. The pre-set zone temperature depends by default on the weekly schedule settings. **Constant temperature** mode enables the user to set a separate pre-set temperature value which will apply in the zone regardless of the time.

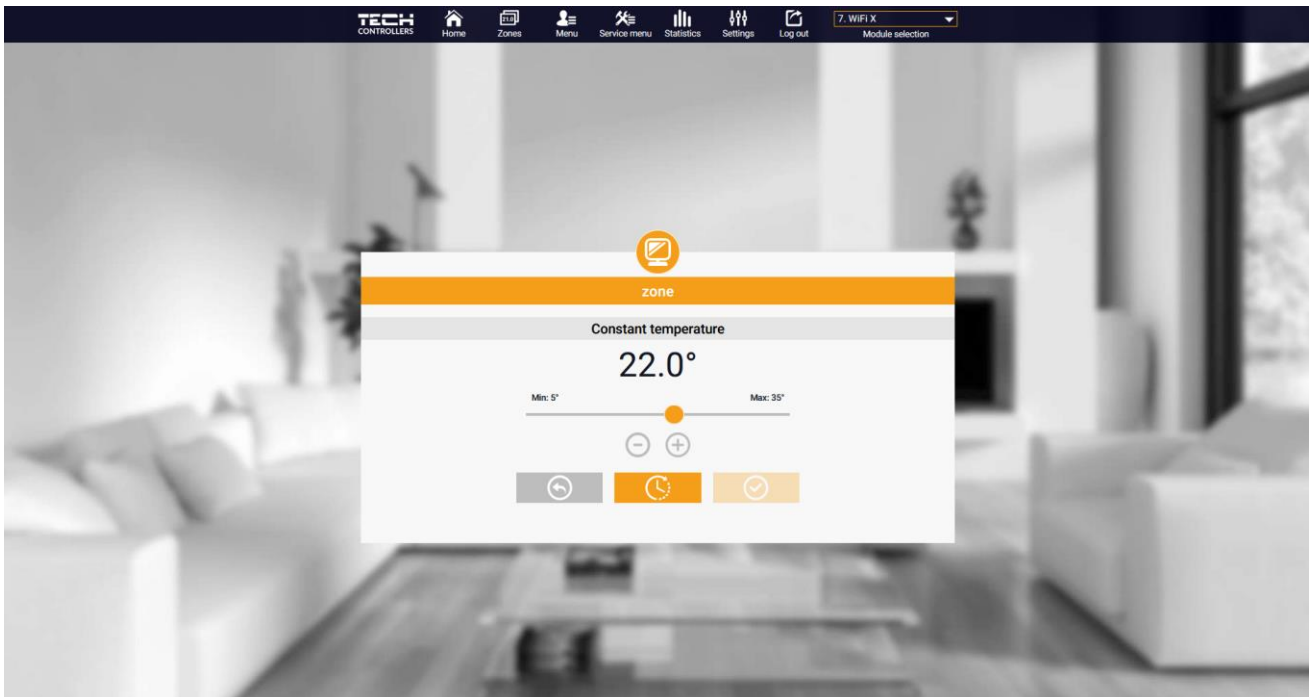

Editing the constant pre-set temperature

By selecting **constant temperature** icon, it is possible to set the temperature **with time limits**.

This mode enables the user to set the temperature value which will apply only within a pre-defined period of time. When the period is over, again the pre-set temperature depends on the weekly schedule settings (schedule or constant temperature without time limit).

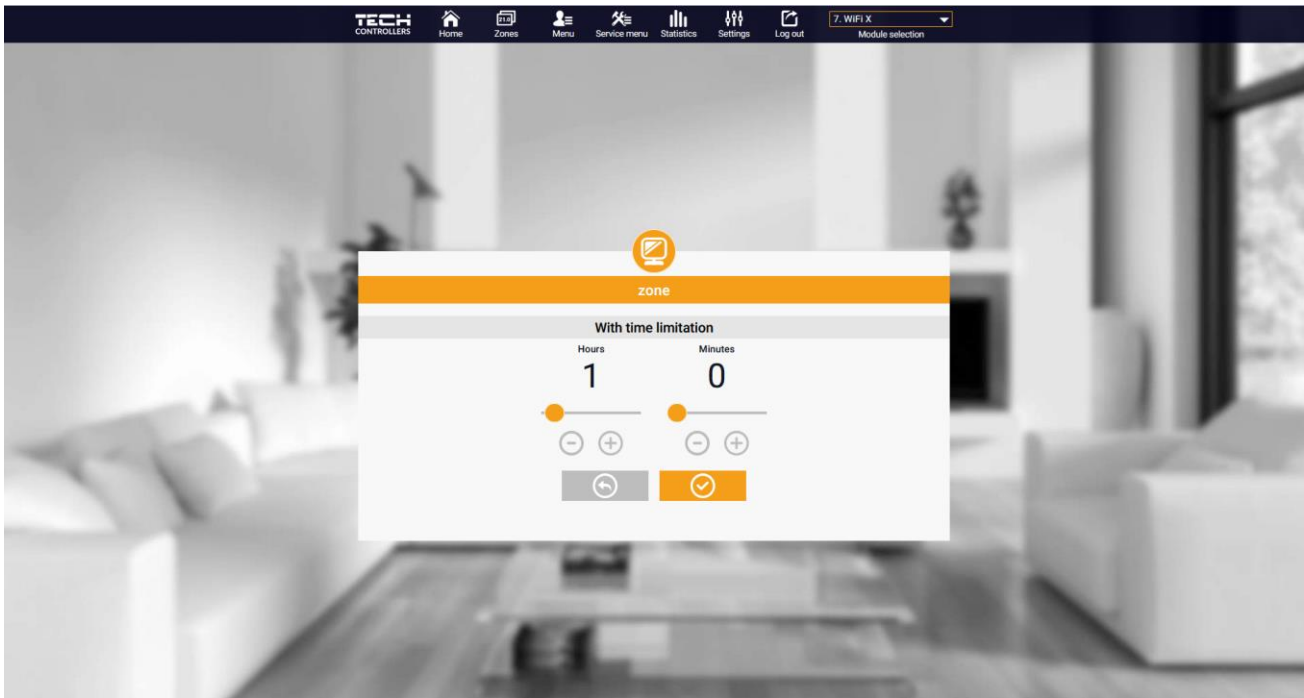

Pre-set temperature with time limits

Tap on **Schedule** icon to open up the schedule selection screen.

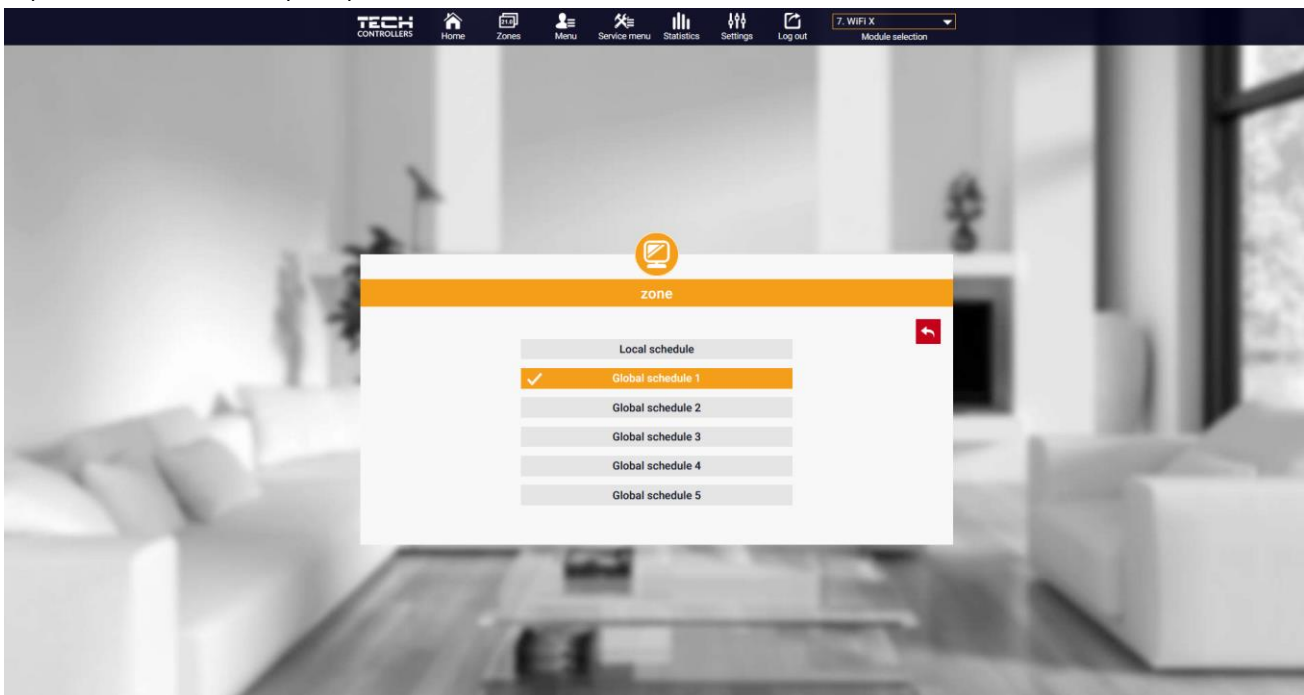

Selecting a weekly schedule

It is possible to set six weekly schedules: 1-local, 5-global. Temperature settings for schedules are common for heating and cooling. The selection of a specific schedule in a given mode is remembered separately.

- **Local schedule** - weekly schedule assigned only to the zone. You can edit it freely.
- **Global schedule 1-5** - possibility of setting several schedules in a zone, but the one marked as active will operate.

After selecting the schedule tap on OK and move on to edit the weekly schedule settings.

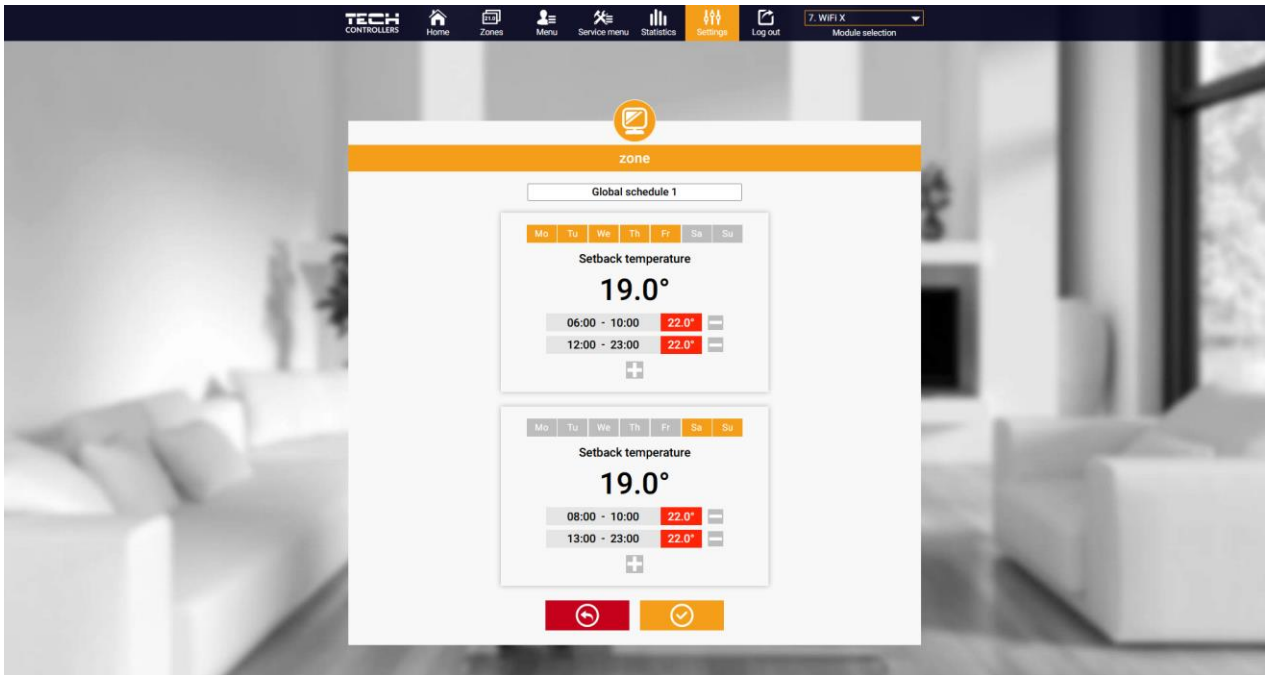

Editing a weekly schedule

Editing enables the user to define two programs and select the days when the programs will be active (e.g. from Monday to Friday and the weekend). The starting point for each program is the pre-set temperature value. For each program the user may define up to 3 time periods when the temperature will be different from the pre-set value. The time periods must not overlap. Outside these time periods the pre-set temperature will apply. The accuracy of defining the time period is 15 minutes.

By tap on the icons on the tiles  the user has an overview of data, parameters and devices in the installation.

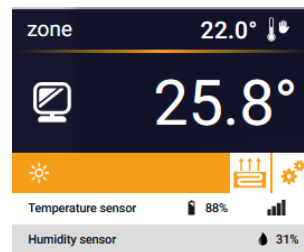
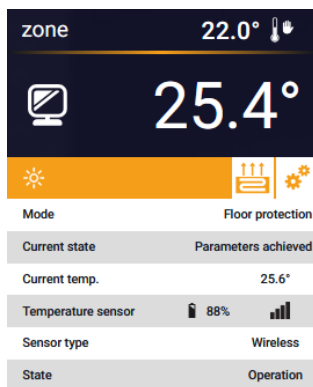

2. ZONES TAB

The user may customize the home page view by changing the zone names and the corresponding icons.

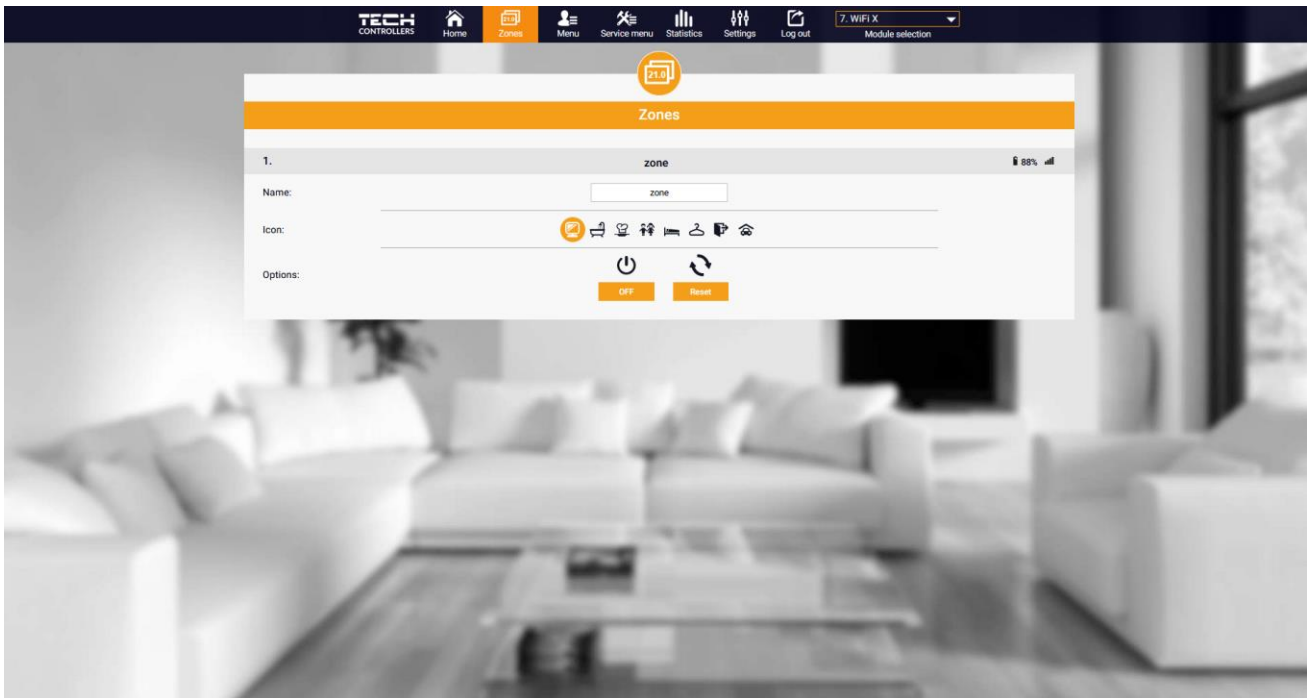

Zones tab

3. MENU TAB

The tab contains all the functions supported by the driver. The user can view and change the settings of specific controller parameters.

3.1. OPERATION TYPE

Select the "Zones" mode and register the controller - the controller then controls the heating/cooling device based on the data from the sensor.

3.2. OPERATING MODE

The function allows selecting a specific operating mode: normal, holiday, economical, comfortable.

3.3. ZONE

3.3.1. ROOM SENSOR

- **Hysteresis** - Room temperature hysteresis introduces tolerance for the room temperature. The range is within $0.1 \div 10^{\circ}\text{C}$ of the selected temperature.
- **Calibration** - Room sensor calibration is carried out during assembly or if the displayed room temperature deviates from the actual. Adjustment range is from -10°C to $+10^{\circ}\text{C}$ with a step of 0.1°C .
- **Delete sensor** – this function allows deleting the registered room sensor.



PLEASE NOTE!

To re-register the sensor, unscrew the controller housing and remove the cover (*see chapter IV.4*)!

3.3.2. FLOOR HEATING

➤ Operation type

- **Disabled** – the function allows disabling of the type of operation.
- **Floor Protection** – this function is used to keep the floor temperature below the set maximum temperature. The purpose is to protect the system from overheating. When the temperature rises to the set maximum temperature, the reheating of the zone will be switched off.
- **Comfort mode** – This function is used to maintain a comfortable floor temperature, i.e. the controller will monitor the current temperature. Once the temperature rises to the set maximum temperature, the zone heating will be switched off to protect the system from overheating. Once the floor temperature drops again below the set minimum temperature, the reheating of this zone will be switched back on.
- **Floor temperature max./min.** – the function allows setting the maximum and minimum floor temperature. Based on the set max. temperature, the *Floor Protection* function prevents the floor from overheating. In contrast, the min. temperature prevents the floor from underheating. These settings allow the maintenance of a comfortable temperature regime within the room.

NOTE!



In the "Floor protection" operating mode, only the maximum temperature appears, while in the comfort mode, the minimum and maximum temperatures appear!

➤ Floor Sensor

- **Hysteresis** - Floor temperature hysteresis introduces tolerance for the set floor temperature. This range is between $0.1 \div 10^{\circ}\text{C}$.
- **Calibration** - Floor sensor calibration is carried out during assembly or if the displayed floor temperature deviates from the actual. Adjustment range is from -10°C to $+10^{\circ}\text{C}$ with a step of 0.1°C .
- **Delete sensor** - the function allows deleting the registered floor sensor.

PLEASE NOTE!



To re-register the floor sensor, unscrew the controller housing and remove the cover (*cf. sec. IV.4!*)

3.3.3. SETTINGS

➤ Heating

- **Enabled** – this function allows switching on the heating mode.
- **Set temperature** – this option enables selection of a specific work schedule in the zone.
- **Temperature settings** – this option enables selection of set temperature for the holiday, economy and comfort modes.

➤ Cooling*

- Enabled
- Set temperature
- Temperature settings

* The parameter settings are edited in the same way as in the "Heating" function.

3.4. HEATING - COOLING

3.4.1. OPERATING MODE

- **Automatic** – varies depending on the heating/cooling input - in the absence of signal, it operates in heating mode
- **Heating** – the zone is heated
- **Cooling** – the zone is cooled.

3.5. PROTECTION - HUMIDITY

Protection – humidity – If the humidity in the zone is greater than the set value in the emodul.pl, cooling in this zone will be switched off.

NOTE! This function works only in the "Cooling" mode!

3.6. FACTORY DEFAULTS

This function allows restoring the factory settings of the controller. The default operating mode is "contact".

If the controller is to operate as a "Zone", select the "Zone" type of operation and register the sensor. A tile with individual zone parameters will then appear on the main screen.

3.7. INTERNET MODULE

Internet module – the WiFi module can be connected to the Internet. However, the device must be connected to the same network as the controller. To do so, enter the displayed IP address in the web browser so as to access the parameters of the Configuration Portal, e.g. for downloading the current version of the software.

4. SERVICE MENU

The service menu is available only to qualified installers and is protected by a code that can be made available by the Tech Sterowniki service. When contacting the service, please provide the controller software version number.

5. STATISTICS TAB

The Statistics tab enables the user to view the temperature charts for different time periods e.g. 24h, a week or a month. It is also possible to view the statistics for the previous months.

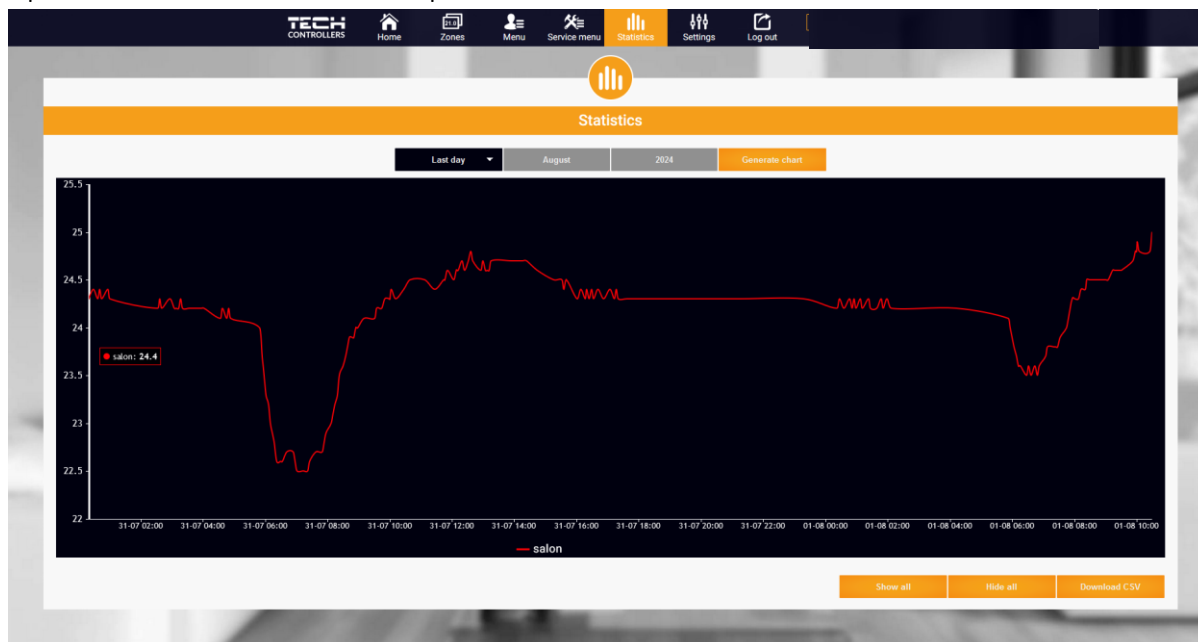

En example chart

6. SETTINGS TAB

The settings tabs allow you to edit user data and view module parameters and register a new one.

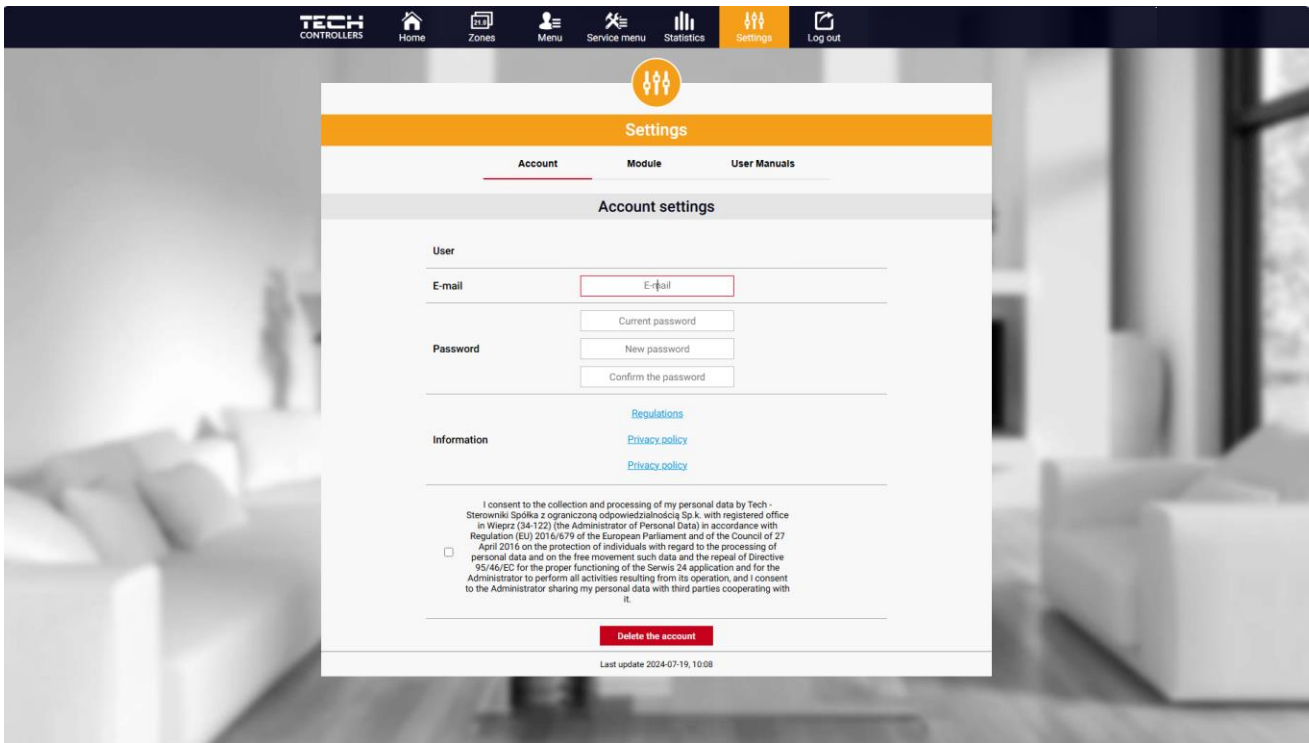

Settings/Account tab

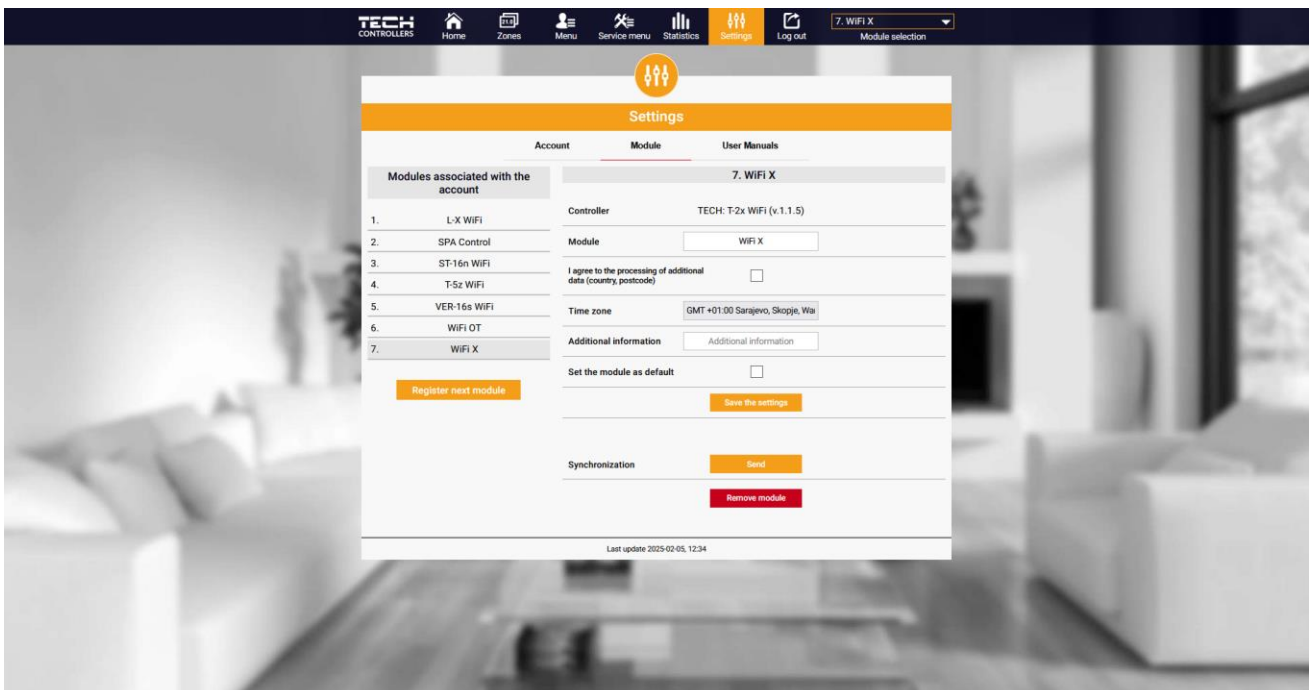

Settings/Module tab

VI. SOFTWARE UPDATE

To update the driver and module, select the "Setup Portal" tab on your phone and select the "... update" option or download and upload the file.

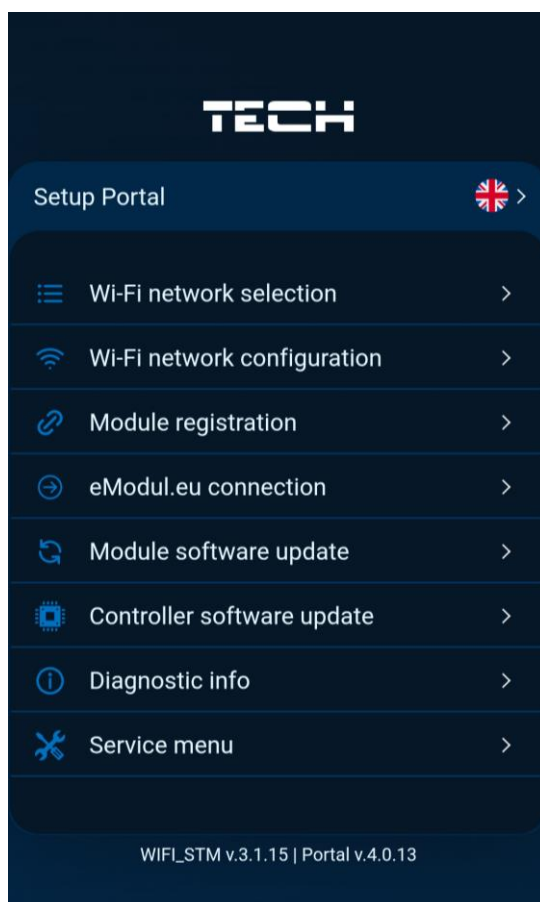

This option also allows you to view the current version of the program, which is needed to contact the Tech Sterownik service.



NOTE

The update is performed separately for the controller and the module.

VII. TECHNICAL DATA

Specification	Value
Power supply	230V +/-10% / 50Hz
Max. power consumption	1,3W
Operation temperature	5÷50°C
Potential-free cont. nom. out. load	230V AC / 0,5A (AC1) * 24V DC / 0,5A (DC1) **
Frequency	868MHz
Transmission	IEEE 802.11 b/g/n

* AC1 load category: single-phase, resistive or slightly inductive AC load.

** DC1 load category: direct current, resistive or slightly inductive load.



EU DECLARATION OF CONFORMITY

Hereby, we declare under our sole responsibility that **EU-WiFi X** manufactured by TECH STEROWNIKI II Sp. z o.o., head-quartered in Wieprz Biała Droga 31, 34-122 Wieprz, is compliant with Directive **2014/53/EU** of the European parliament and of the Council of 16 April 2014 on the harmonisation of the laws of the Member States relating to the making available on the market of radio equipment, Commission Delegated Regulation (EU) 2022/30 of 29 October 2021 supplementing Directive 2014/53/EU with regard to the application of the essential requirements concerning cybersafety (Art. 3(3) points (d) and (e), Directive **2009/125/EC** establishing a framework for the setting of ecodesign requirements for energy-related products as well as the regulation by the MINISTRY OF ENTREPRENEURSHIP AND TECHNOLOGY of 24 June 2019 amending the regulation concerning the essential requirements as regards the restriction of the use of certain hazardous substances in electrical and electronic equipment, implementing provisions of Directive (EU) 2017/2102 of the European Parliament and of the Council of 15 November 2017 amending Directive 2011/65/EU on the restriction of the use of certain hazardous substances in electrical and electronic equipment (OJ L 305, 21.11.2017, p. 8).

For compliance assessment, harmonized standards were used and technical standards:

PN-EN IEC 60730-2-9 :2019-06 art. 3.1a Safety of use

PN-EN IEC 62368-1:2020-11 art. 3.1 a Safety of use

PN-EN 62479:2011 art. 3.1 a Safety of use

ETSI EN 301 489-1 V2.2.3 (2019-11) art.3.1b Electromagnetic compatibility

ETSI EN 301 489-3 V2.1.1 (2019-03) art.3.1 b Electromagnetic compatibility

ETSI EN 301 489-17 V3.2.4 (2020-09) art.3.1b Electromagnetic compatibility

ETSI EN 300 328 V2.2.2 (2019-07) art.3.2 Effective and coherent use of radio spectrum

ETSI EN 300 220-2 V3.2.1 (2018-06) art.3.2 Effective and coherent use of radio spectrum

ETSI EN 300 220-1 V3.1.1 (2017-02) art.3.2 Effective and coherent use of radio spectrum

EN 18031-1:2024 Art. 3(3)(d) common security requirements for radio equipment, Internet connected radio equipment,

EN 18031-2:2024 Art. 3(3)(e) radio equipment processing data, namely, Internet connected radio equipment,

PN EN IEC 63000:2019-01 RoHS.

Wieprz, 17.12.2025

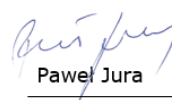
Paweł Jura

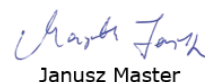
Janusz Master

Prezesa firmy

**TECH
TECH
CONTROLLERS**

Central headquarters:

ul. Biała Droga 31, 34-122 Wieprz

Service:

ul. Skotnica 120, 32-652 Bulowice

phone: **+48 33 875 93 80**

e-mail: **serwis@techsterowniki.pl**

www.tech-controllers.com