

TECH CONTROLLERS

USER MANUAL EU-293v2

EN

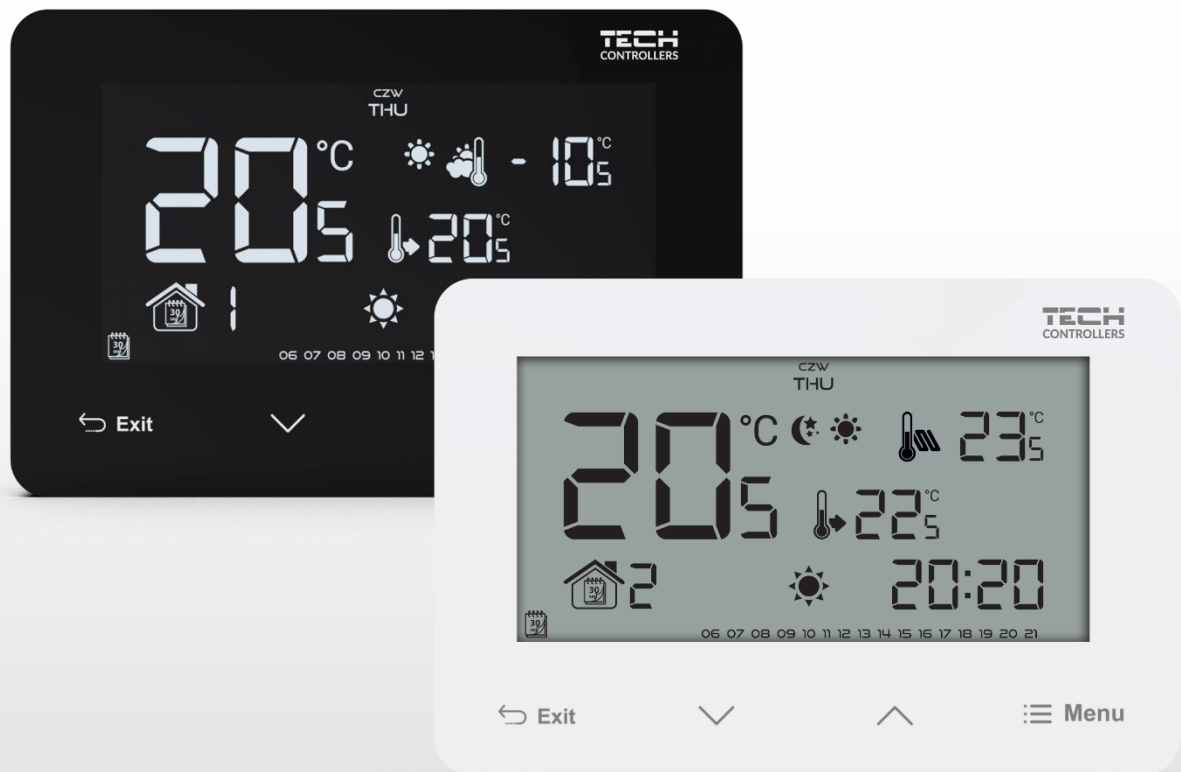

TABLE OF CONTENTS

- I. Safety 3
- II. Device description 4
- III. How to install the controller 5
 - 1. How to install battery-powered regulator 6
 - 2. How to install 230V-powered regulator 7
- IV. Wireless controller receiver 9
- V. First start-up 10
- VI. How to use the controller 10
 - 1. Principle of operation 10
 - 2. Operation modes 10
 - 3. Main screen view and description 13
 - 4. Controller functions 14
 - 4.1. Block diagram - main menu 15
 - 4.2. Day of the week 15
 - 4.3. Clock settings 16
 - 4.4. Day from... 16
 - 4.5. Night from... 16
 - 4.6. Button lock 16
 - 4.7. Optimum start 16
 - 4.8. Automatic manual mode 17
 - 4.9. Weekly program 17
 - 4.10. Pre-set comfort temperature 19
 - 4.11. Pre-set economical temperature 19
 - 4.12. Pre-set temperature hysteresis 20
 - 4.13. Temperature sensor calibration 20
 - 4.14. Registration 20
 - 4.15. Floor sensor 20
 - 4.16. Maximum floor temperature 21
 - 4.17. Minimum floor temperature 21
 - 4.18. Floor temperature hysteresis 21
 - 4.19. Service menu 21
- VII. Technical data 22

JG, 2021.05.17

I. SAFETY

Before using the device for the first time the user should read the following regulations carefully. Not obeying the rules included in this manual may lead to personal injuries or controller damage. The user's manual should be stored in a safe place for further reference.

In order to avoid accidents and errors it should be ensured that every person using the device has familiarized themselves with the principle of operation as well as security functions of the controller. If the device is to be sold or put in a different place, make sure that the user's manual is there with the device so that any potential user has access to essential information about the device.

The manufacturer does not accept responsibility for any injuries or damage resulting from negligence; therefore, users are obliged to take the necessary safety measures listed in this manual to protect their lives and property.



WARNING

- **A live electrical device!** Make sure the regulator is disconnected from the mains before performing any activities involving the power supply (plugging cables, installing the device etc.)
- The device should be installed by a qualified electrician.
- The device should not be operated by children.



WARNING

- The device may be damaged if struck by a lightning. Make sure the plug is disconnected from the power supply during a thunderstorm.
- Any use other than specified by the manufacturer is forbidden.
- The device should be periodically checked.

Changes in the merchandise described in the manual may have been introduced subsequent to its completion on 17.05.2021. The manufacturer retains the right to introduce changes to the structure or colours. The illustrations may include additional equipment. Print technology may result in differences in the colours shown.



We are committed to protecting the environment. Manufacturing electronic devices imposes an obligation of providing for environmentally safe disposal of used electronic components and devices. Hence, we have been entered into a register kept by the Inspection for Environmental Protection. The crossed-out bin symbol on a product means that the product may not be disposed of to household waste containers. Recycling of waste helps to protect the environment. The user is obliged to transfer their used equipment to a collection point where all electric and electronic components will be recycled.

II. DEVICE DESCRIPTION

The EU-293v2 room regulator is intended for controlling the heating or cooling device (e.g. gas, oil or electric boiler or the boiler controller).

Its main task is to maintain the pre-set temperature in the flat by sending a signal to the heating/cooling device (contact opening) when the desired temperature is reached.

Advanced software enables the regulator to fulfil a wide range of functions:

- maintaining the pre-set room temperature
- manual mode
- day/night program
- weekly control
- underfloor heating system control (optional; an additional temperature sensor is necessary)

Controller equipment:

- touch buttons
- front panel made of 1mm glass
- built-in temperature sensor
- batteries (battery-powered version)

The EU-293v2 room regulator offers two display versions:

- standard (the data is displayed in black against white background)
- negative (the data is displayed in white against black background)

Two colour versions are available:

WHITE

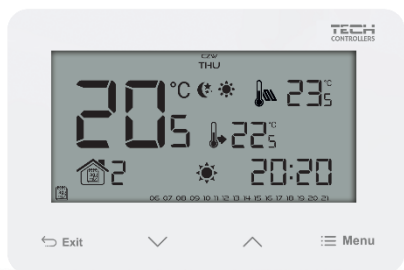

BLACK



EU-293 user's manual

The EU-293v2 works with an additional EU-MW-3 signal receiver (included in the controller set), mounted near the heating device.

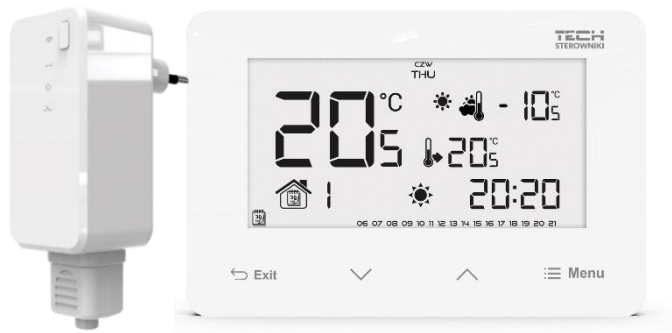

Hardware versions:

1. **EU-293 B v2** – wireless version, powered with two AAA 1,5V batteries, with a temporary backlight.
Colour versions: black or white.
2. **EU-293 Z v2** – wireless version, powered with 230V, with a temporary backlight.
Colour versions: black or white.

III. HOW TO INSTALL THE CONTROLLER

NOTE



The device should be installed by a qualified electrician.

WARNING

If pump manufacturer requires an external main switch, power supply fuse or additional residual current device selective for distorted currents it is recommended not to connect pumps directly to pump control outputs.

To avoid damaging to the device, an additional safety circuit must be used between the regulator and the pump. The manufacturer recommends the ZP-01 pump adapter, which must be purchased separately.

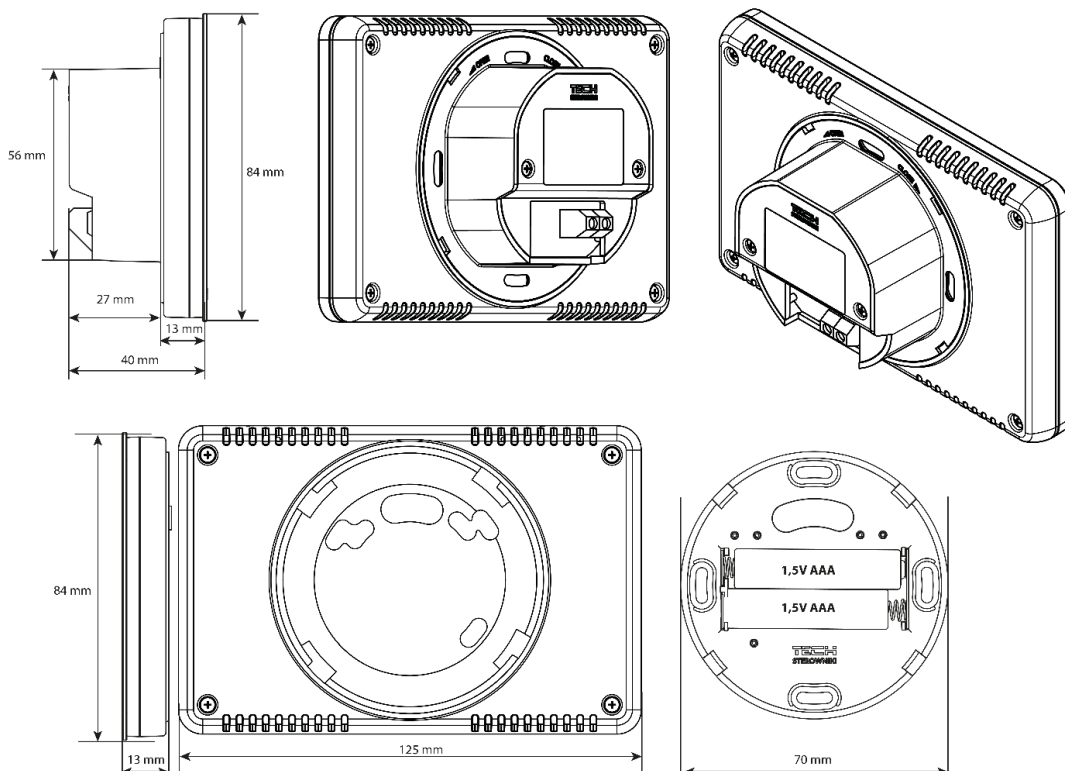

1. HOW TO INSTALL BATTERY-POWERED REGULATOR

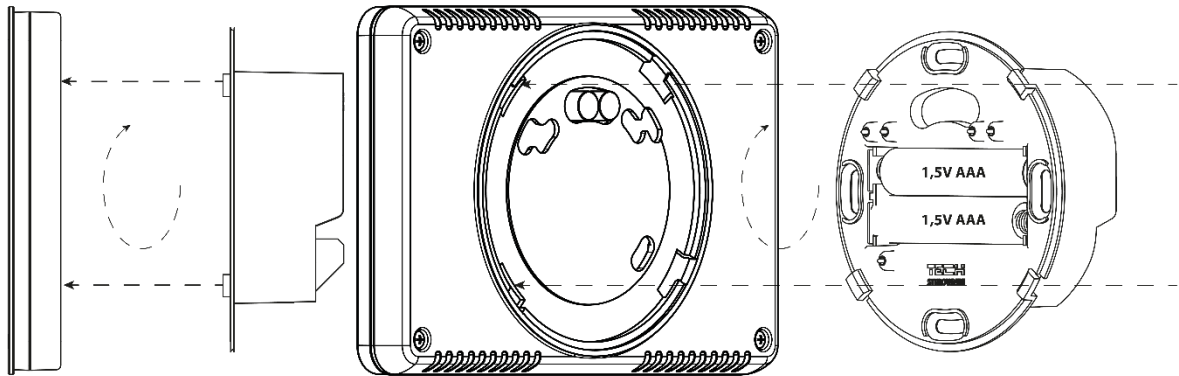

➤ **The EU-293v2 room regulator - connection diagram**

In order to install the device properly, follow the diagram below. A two-core communication cable should be connected to appropriate ports in the receiver.

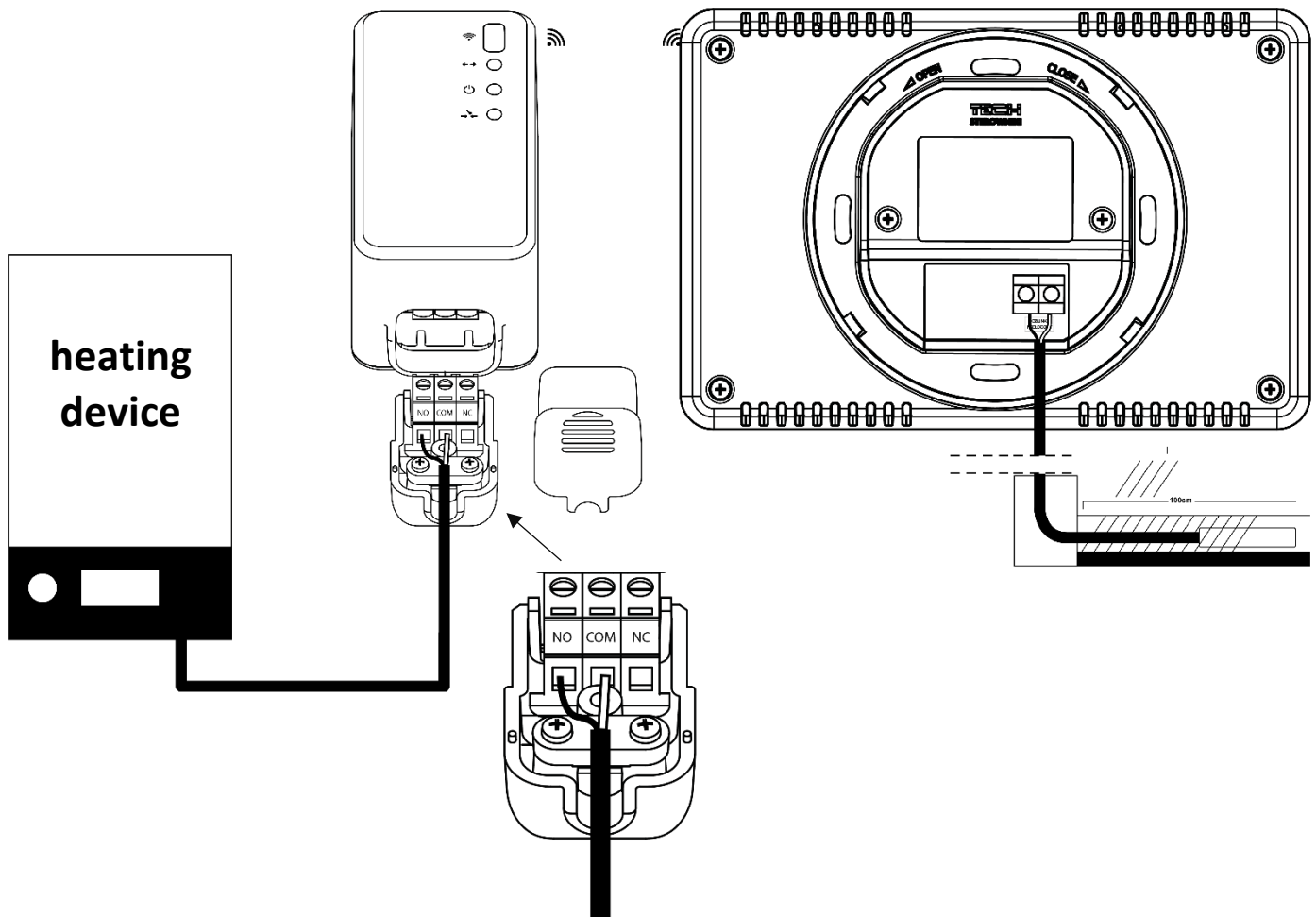

The EU-293v2 room regulator may be used as a wall-mountable panel. In order to mount it, place the rear part of the controller in the mounting box on the wall, insert the regulator and turn it slightly.



2. HOW TO INSTALL 230V-POWERED REGULATOR

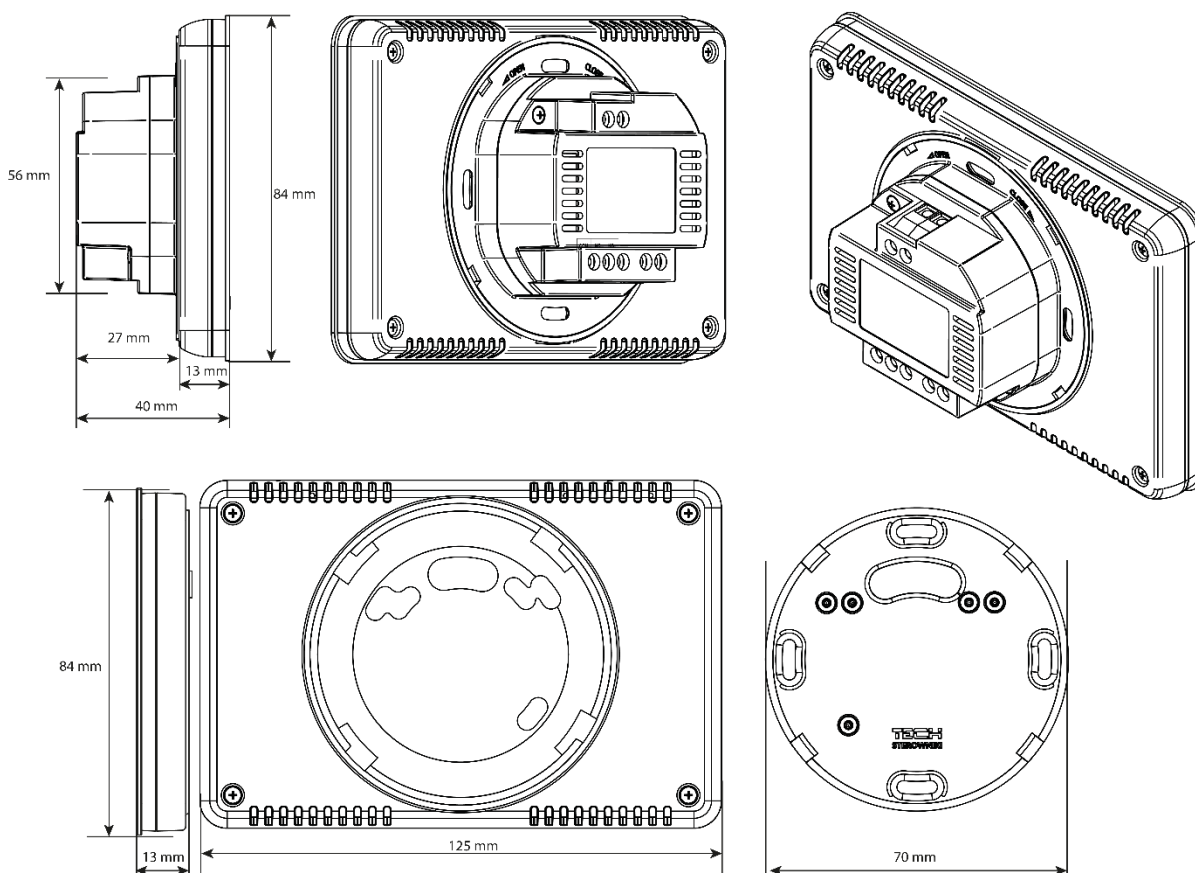

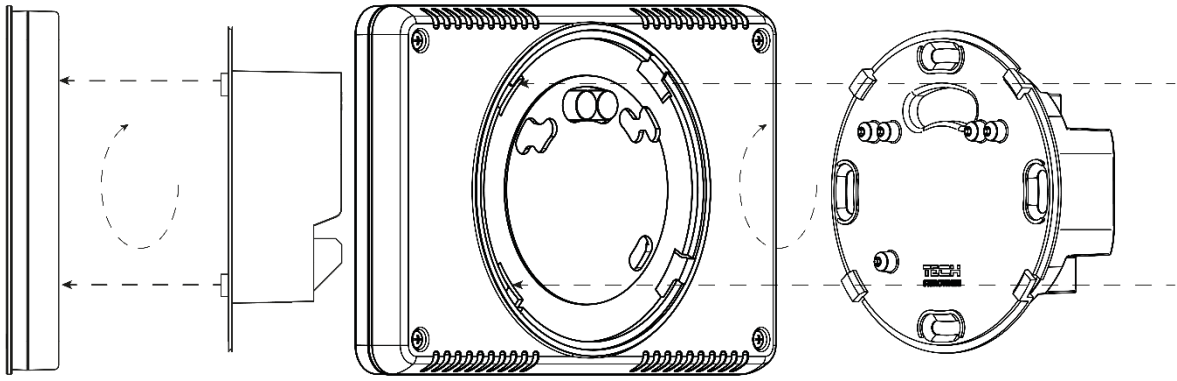

➤ **The EU-293z v2 room regulator - connection diagram**

In order to install the device properly, follow the diagram below. A two-core communication cable should be connected to appropriate ports in the receiver.

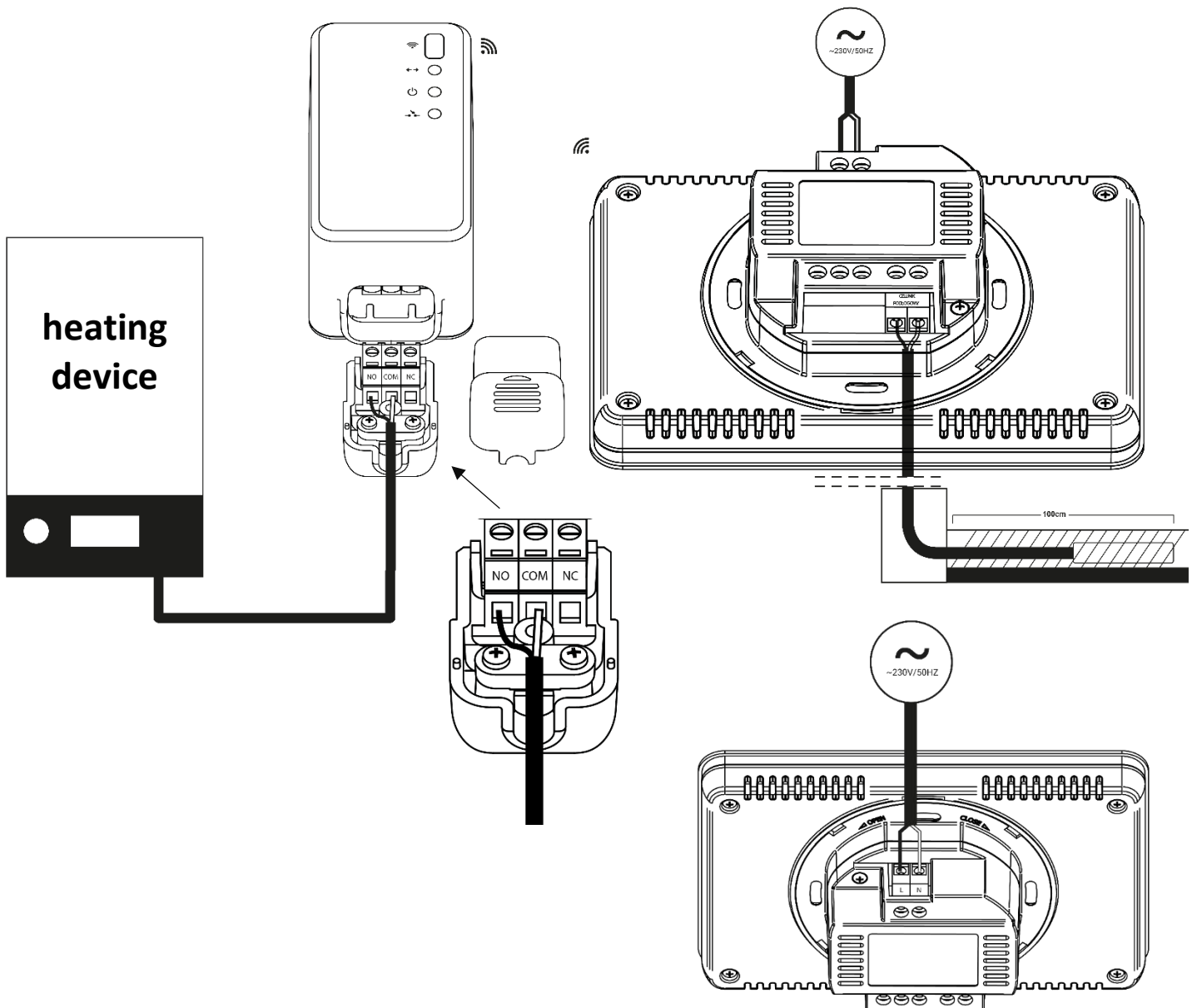

IV. WIRELESS CONTROLLER RECEIVER

The EU-293v2 regulator communicates with the heating device (or the CH boiler controller) by means of a radio signal sent to the EU-MW-3 receiver. Such a receiver is connected to the heating device (or the CH boiler controller) by means of a two-core cable, and communicates with the room regulator using a radio signal.

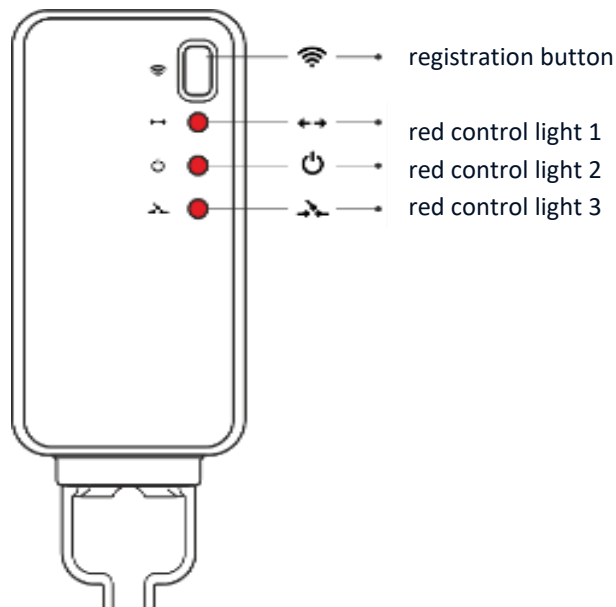

The receiver has three control lights:

- red control light 1 – it signalises data reception;
- red control light 2 – indicates receiver operation;
- red control light 3 – goes on when the room temperature fails to reach the pre-set value – the heating device is switched on.



NOTE

- In case of no communication (e.g. due to discharged battery), the receiver automatically disables the heating device after 15 minutes.

Registration of the EU-MW-3 receiver:

In order to register relays, select the *Reg* function in the menu and hold the Menu button or press one of the buttons \checkmark \wedge . *Scs* displayed on the screen means that the registration has been successful. If any errors occurred during the registration, the screen displays *Err*. In both cases it is possible to continue registration by pressing any button (except for Exit).

The number of registered relays is displayed on the screen. If 6 relays have been registered (the maximum number), it is possible to unregister them - *Del* function appears on the screen. Use one of the buttons \checkmark \wedge to select YES or NO.

V. FIRST START-UP

In order for the EU-293v2 controller to operate correctly, follow these steps when starting the device for the first time:

1. Insert the batteries - in order to do it, remove the controller back cover (battery-powered version).
2. If the room regulator is to control the floor heating system, connect an additional sensor to the floor sensor connector.
3. Connect the two-core cable to appropriate sockets in the receiver.



NOTE

Only one room regulator may be assigned to each zone. Assigning more than one room regulator will make it impossible for the external controller to work properly.

VI. HOW TO USE THE CONTROLLER

1. PRINCIPLE OF OPERATION

The EU-293v2 room regulator is designed to maintain the pre-set room temperature by sending a signal to the heating/cooling device (contact opening) when the pre-set room temperature has been reached. After receiving such a signal, the heating/cooling device is disabled (if it is connected to a CH boiler controller, the CH boiler switches to sustain mode after receiving the signal).

If the regulator is used in heating mode, it may also cooperate with a floor sensor. In such a situation, the contact remains closed when the floor temperature is below the minimum threshold. After the threshold temperature has been exceeded, the contact remains closed until the pre-set room temperature is reached. If the floor sensor temperature exceeds the maximum value, the controller will open the contact regardless of the current room temperature.



NOTE

For the floor heating functions to be available in the controller menu, an additional sensor must be connected to the floor sensor contact.

2. OPERATION MODES

The room regulator may operate in one of the following operation modes:

- **Day/night mode**

In this mode the pre-set temperature value depends on the current time of the day. The user may set different temperature values for the daytime and nighttime (comfort temperature and economical temperature) as well as define the exact time of entering day mode and night mode.

In order to activate this mode, press EXIT button until *day/night mode* icon appears on the main screen.

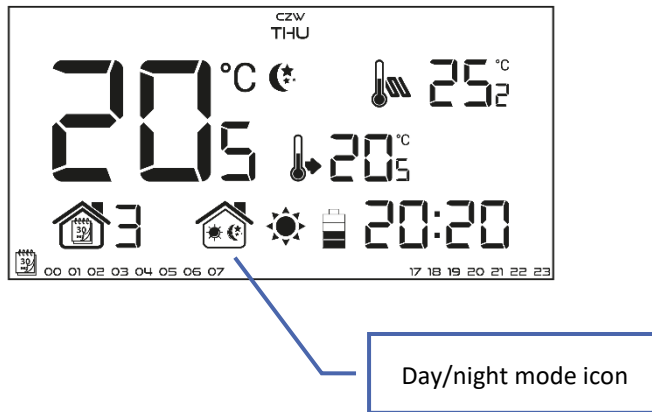

- **Weekly control**

This mode enables the user to define the time when the pre-set comfort temperature and the pre-set economical temperature will apply. The user may set 9 different programs divided into three groups:

- **PROGRAMS 1÷3** – daily temperature values are set for all days of the week;
- **PROGRAMS 4÷6** – daily temperature values are set separately for the weekdays (Monday-Friday) and for the weekend (Saturday-Sunday);
- **PROGRAMS 7÷9** – daily temperature values are set for each day of the week separately.

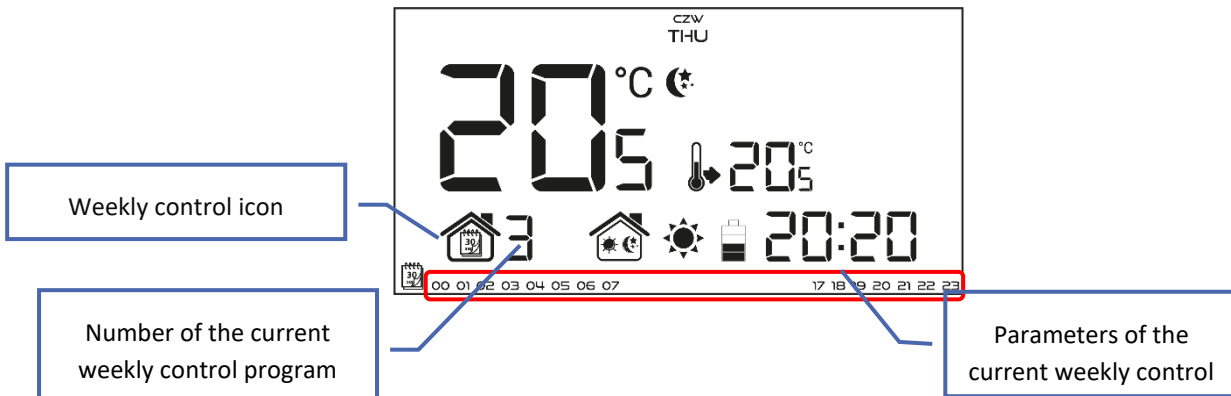

* The display shows the hours when the comfort temperature applies. In the remaining time period economical temperature applies.

In order to activate this mode, press EXIT until a weekly control icon appears on the main screen.

- **Manual mode**

In this mode the pre-set temperature is adjusted manually from the main screen view with the use of these buttons:

^ v . Manual mode is activated automatically when one of these buttons is pressed. Once the manual mode is activated, the previous operation mode enters *sleep mode* until the next pre-programmed temperature change. Manual mode may be deactivated by pressing EXIT button.

Example 1 – manual mode activation in Day/night mode

When *Day/night mode* is active, the user changes the pre-set temperature by pressing one of the buttons ∇ \wedge which automatically activates manual mode. The controller returns to Day/night mode when daytime changes into nighttime (or the other way round) or when the user presses EXIT

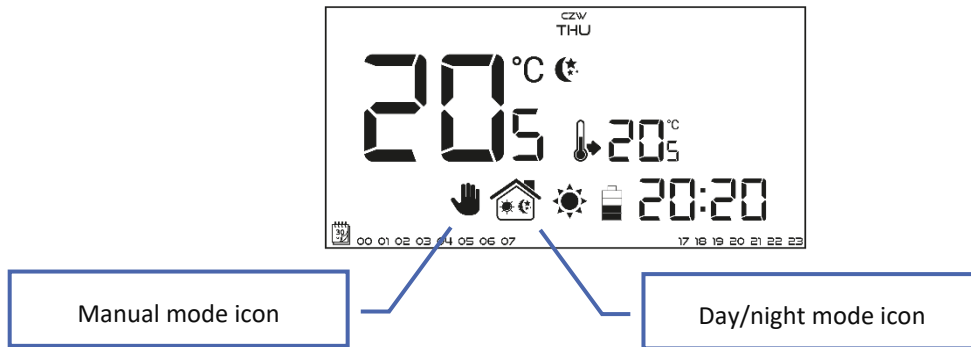

Example 2 – manual mode activation in weekly control mode

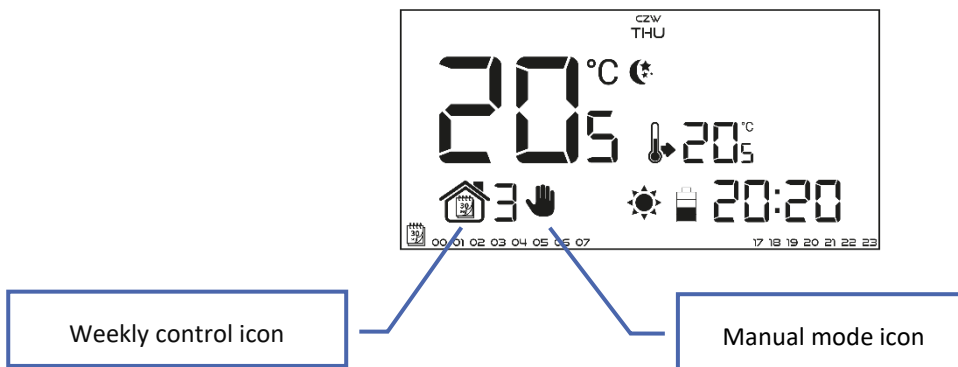

When *Weekly control* is active, the user changes the pre-set temperature by pressing one of the buttons ∇ \wedge which automatically activates manual mode. The controller returns to weekly control mode when, according to the weekly schedule, economical temperature changes into comfort temperature (or the other way round) or when the user presses EXIT.



3. MAIN SCREEN VIEW AND DESCRIPTION

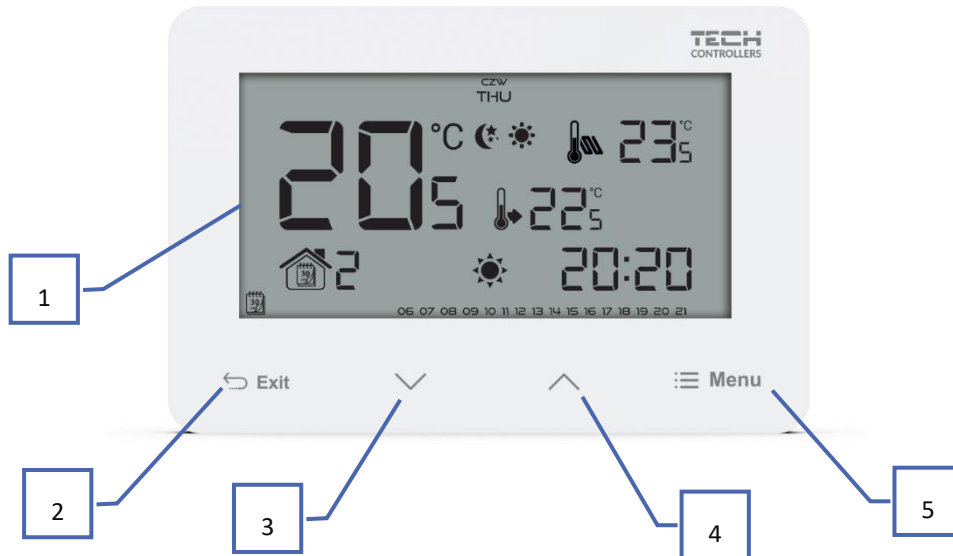





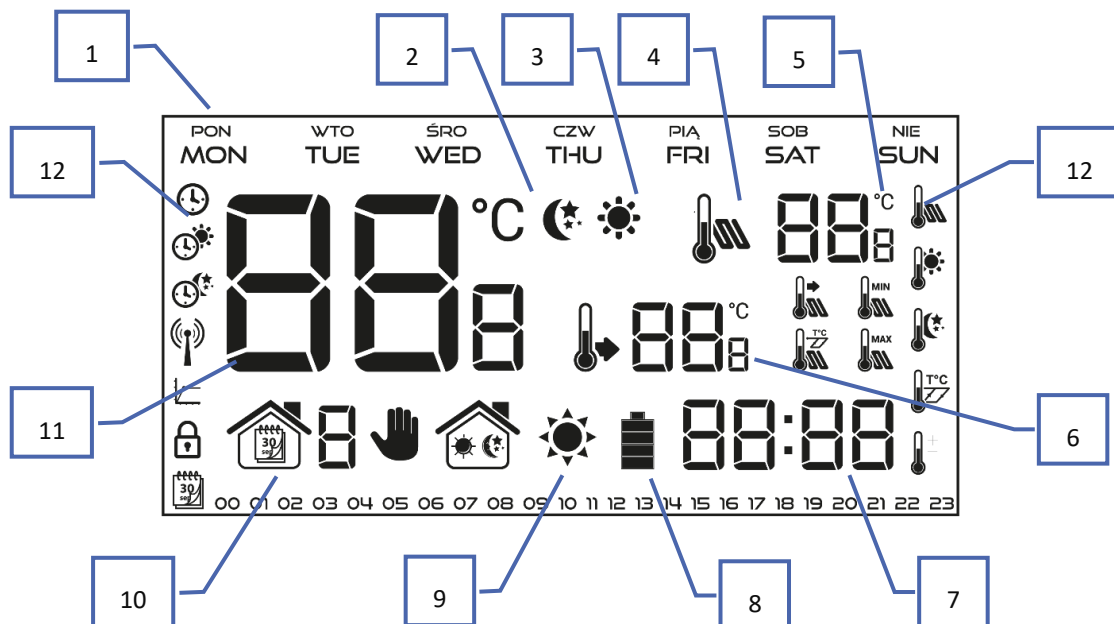



The user operates the device using touch buttons. While one parameter is being edited, the remaining icons are not displayed.



1. Display
2. EXIT in the main screen view - press this button to activate the weekly control or day/night mode. In the controller menu, use this button to confirm the settings and return to the main screen view.
3.  in the main screen view - press this button to switch to manual mode and decrease the pre-set temperature value. In the controller menu, use this button to change parameter settings , enter the service code etc.
4.  in the main screen view - press this button to switch to manual mode and increase the pre-set temperature value. In the controller menu, use this button to change parameter settings , enter the service code etc.
5. MENU – hold this button to enter the controller menu. While editing parameters, press this button to confirm the changes and move on to edit the next parameter.



1. Day of the week
2. An icon informing about current economical temperature (resulting from weekly control or day/night mode settings).
3. An icon informing about current comfort temperature (resulting from weekly control or day/night mode settings).
4. An icon informing about displaying current floor temperature (point 6 on the display) - a floor sensor must be and registered in the controller menu.
5. Floor temperature
6. Pre-set room temperature
7. Time
8. Battery level (this icon is displayed only in the battery-powered version).
9. An icon informing about room cooling/heating. The animation differs depending on the selected operation mode:
 - Heating mode – the icon flashes when the pre-set temperature has not been reached; it is steady when the pre-set temperature has been reached.
 - Cooling mode – the icon rotates when the temperature is above the pre-set value; it is steady when the pre-set temperature has been reached.
10. Current operation mode:
 - a. Weekly
 - b. Manual
 - c. Day/night
11. Current room temperature
12. Parameter icons (see: a table below)

Parameter icons:			
	Clock settings		Floor sensor
	Day from...		Comfort temperature
	Night from...		Economical temperature
	Optimum start / heating/cooling mode selection (in service menu)		Hysteresis
	Button lock		Temperature sensor calibration
	Weekly control settings		

4. CONTROLLER FUNCTIONS

The user navigates the menu structure using ∇ \wedge , EXIT and MENU. In order to edit particular parameters, press MENU. Next, press MENU to view the controller functions – the edited parameter is flashing whereas the remaining parameters are not displayed. Use ∇ \wedge to change the parameter settings. Press MENU to confirm the changes and move on to edit the next parameter or press and EXIT to confirm the changes and return to the main screen view.

4.1. BLOCK DIAGRAM - MAIN MENU

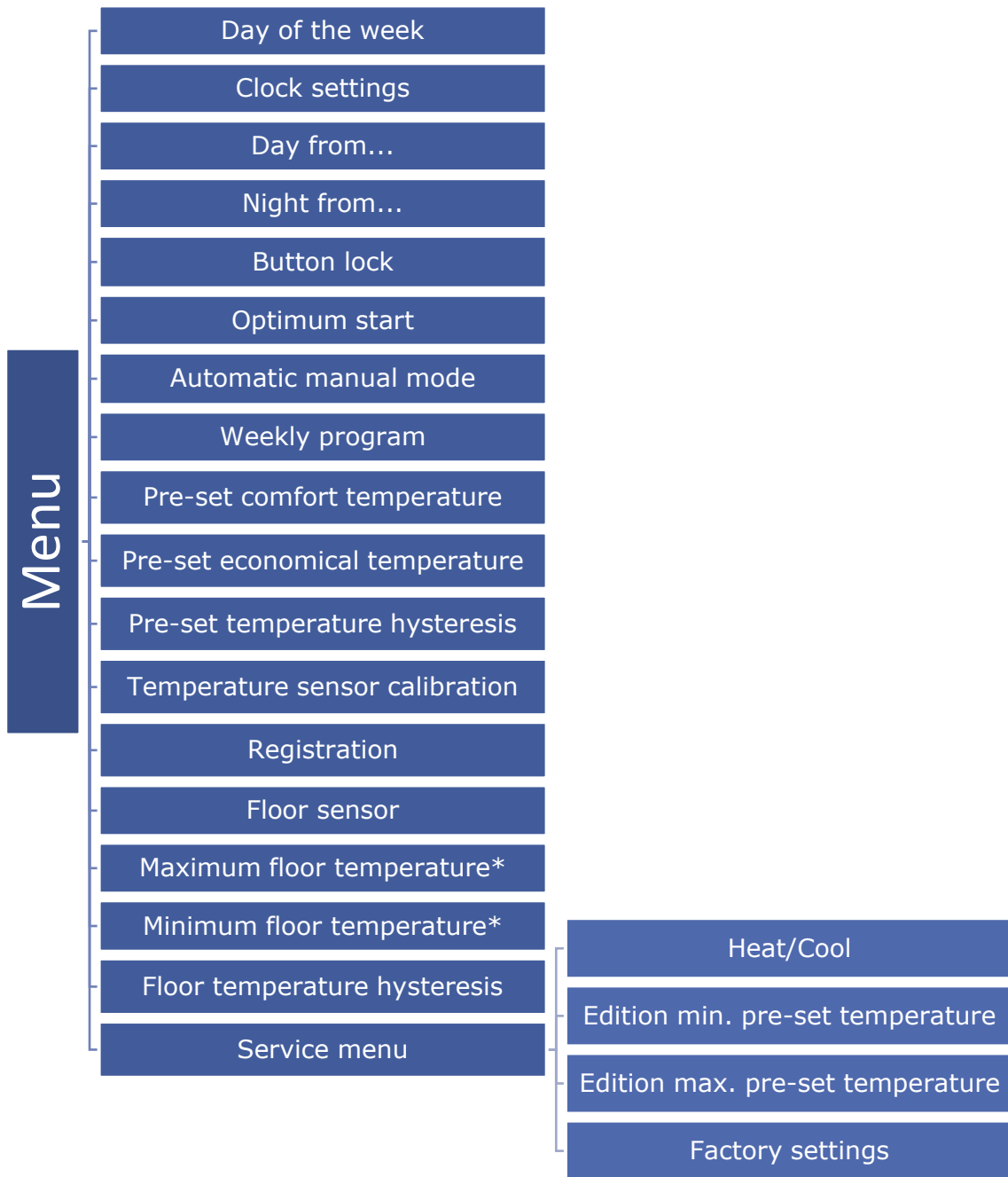

*These functions are displayed only after the additional sensor has been connected to the floor sensor contact and activated in the controller menu by selecting *ON* in the *Floor sensor* submenu.

4.2. DAY OF THE WEEK

After entering the main menu, all icons which are not connected with the parameter which is being edited are not displayed. The first parameter is day of the week. Press ∇ or \blacktriangle until the current day of the week is displayed.

Press MENU to confirm and move on to the next parameter or press EXIT to confirm and return to the main screen view.

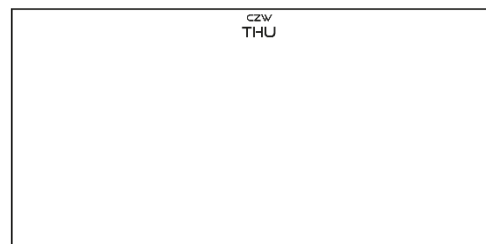

4.3. CLOCK SETTINGS

In order to set current time, press MENU until time setting panel is displayed on the screen. By pressing ∇ or \wedge set the hour and minutes.

Press MENU to confirm and move on to the next parameter or press EXIT to confirm and return to the main screen view.



4.4. DAY FROM...

This function enables the user to define the exact time of entering the day mode. When Day/night mode is active, comfort temperature applies at daytime. To configure this parameter press MENU until *Day from...* setting appears on the screen. By pressing ∇ or \wedge set the hour and minute of day mode activation.

Press MENU to confirm and move on to the next parameter or EXIT to confirm and return to the main screen view.



4.5. NIGHT FROM...

This function enables the user to define the exact time of entering the night mode. When Day/night mode is active, economical temperature applies at nighttime. To configure this parameter press MENU until *Night from...* setting appears on the screen. By pressing ∇ or \wedge set the hour and minute of night mode activation.

Press MENU to confirm and move on to the next parameter or press EXIT to confirm and return to the main screen view.

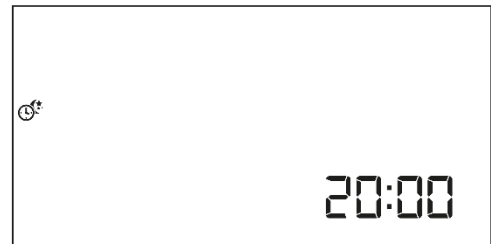

4.6. BUTTON LOCK

In order to activate the button lock, press MENU until a padlock icon appears. Use one of the buttons ∇ or \wedge to select *ON*. In order to unlock the buttons, press and hold the buttons ∇ \wedge at the same time, select the button lock function and select *OFF*.



4.7. OPTIMUM START

Optimum start is an intelligent system controlling the heating/cooling process. It involves constant monitoring of the heating/cooling system efficiency and using the information to activate the heating/cooling in advance in order to reach the pre-set temperatures.

Room temperature -
OPTIMUM START OFF

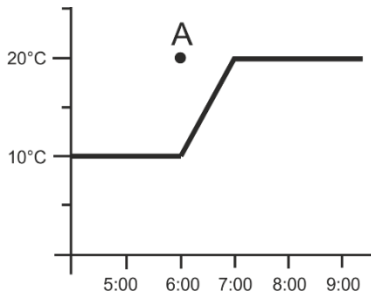

Room temperature -
OPTIMUM START ON

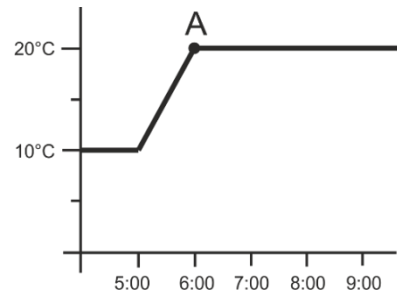

A – pre-programmed change from economical temperature to comfort temperature

Activating this function means that at the time of pre-programmed change of the pre-set temperature determined by the schedule, the current room temperature will be close to the desired value.

In order to activate this function, press MENU until Optimum start settings appear. Use the buttons ∇/\wedge to activate/deactivate the function.

Press MENU to confirm and move on to the next parameter or press EXIT to confirm and return to the main screen view.

4.8. AUTOMATIC MANUAL MODE

This function enables manual mode control. If this function is active (ON), the manual mode is disabled automatically when a pre-programmed change resulting from the previous operation mode is introduced. If the function is disabled (OFF), the manual mode remains active regardless of the pre-programmed changes.

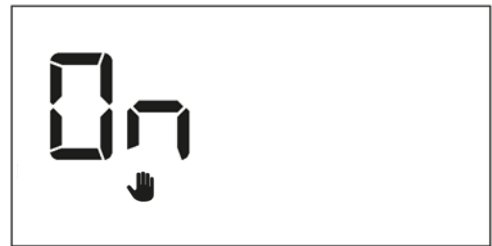

4.9. WEEKLY PROGRAM

This function is used to change the current weekly control program and edit the weekly programs.

- HOW TO CHANGE WEEKLY PROGRAM NUMBER

When weekly control is enabled (see: VII.2. *Operation modes*) the current program is activated. In order to choose the program number, press MENU until weekly program settings appear on the screen.

By pressing and holding MENU button the user opens up the program selection screen. Each time the user holds the MENU button, the program number changes. When the desired number appears on the screen, press MENU – the controller returns to the main screen view and the selected program number is set.

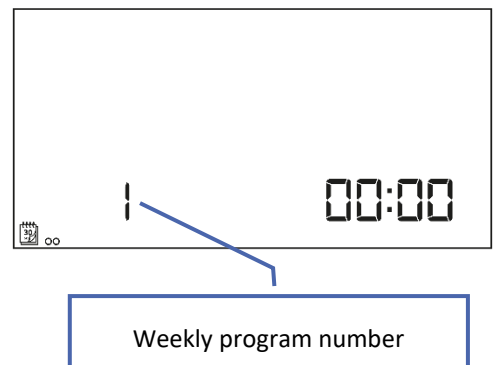

• **HOW TO CONFIGURE PARTICULAR WEEKLY PROGRAMS**

Weekly program allows the user to define the time when comfort temperature and economical temperature will apply. Depending on the program number, the user may set daily temperature values for all days of the week (programs 1÷3), for weekdays and the weekend separately (programs 4÷6) and for each day of the week separately (programs 7÷9).

In order to edit weekly program, press MENU until weekly program setting screen opens up.

STEP 1 – CHOOSE THE PROGRAM TO BE EDITED:

By pressing and holding MENU button the user opens up the program editing screen. Each time the user holds the MENU button, the program number changes. When the desired number appears on the screen, the user may start editing its parameters.

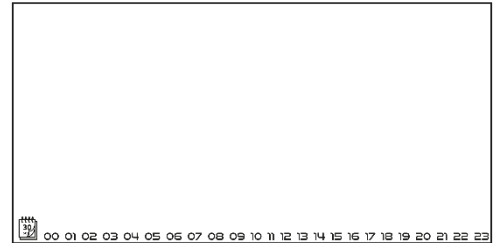

Weekly program number



STEP 2 – SELECT DAYS OF THE WEEK

If the user wants to edit programs 1÷3, there is no possibility of selecting particular days of the week as the setting applies to each day.

If the user wants to edit programs 4÷6, it is possible to edit the settings for weekdays and the weekend separately. Press MENU briefly in order to select.

Editing weekdays parameters

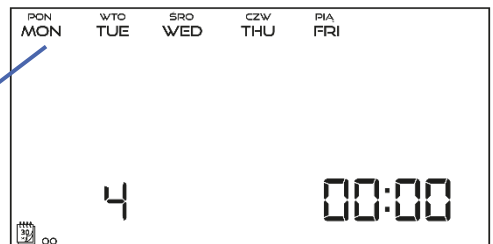

If the user wants to edit programs 7÷9, it is possible to edit the settings for each day separately. Press MENU briefly in order to select a day.

Editing parameters for Monday



STEP 3 – ASSIGN COMFORT TEMPERATURE OR ECONOMICAL TEMPERATURE TO PARTICULAR HOURS

An hour which is being edited is displayed on the controller screen. In order to assign comfort temperature, press \wedge . In order to select economical temperature, press \vee . The controller automatically moves on to editing the next hour.

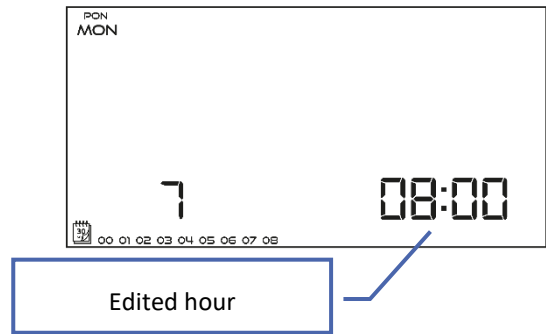

The parameters of the weekly program are displayed at the bottom of the screen: hours to which comfort temperature has been assigned are displayed whereas hours to which economical temperature has been assigned are not displayed.

Example:

The following screenshot presents daily settings of program no. 7 for Monday

- 24⁰⁰-01⁵⁹- economical temperature
- 02⁰⁰-06⁵⁹- comfort temperature
- 07⁰⁰-14⁵⁹- economical temperature
- 15⁰⁰-21⁵⁹- comfort temperature
- 22⁰⁰-00⁵⁹- economical temperature

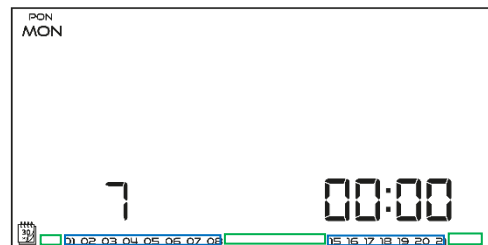

NOTE

When the user finishes the editing process by pressing EXIT button, the controller returns to the main screen view and this program is selected as the current program.

4.10. PRE-SET COMFORT TEMPERATURE

Pre-set comfort temperature is used in weekly control mode and day/night mode. Press MENU button until the comfort temperature change screen opens up. Press \vee or \wedge to set the desired temperature.

Press MENU to confirm and move on to the next parameter or press EXIT to confirm and return to the main screen view.

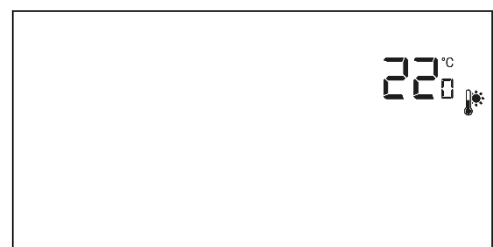

4.11. PRE-SET ECONOMICAL TEMPERATURE

Pre-set economical temperature is used in weekly control mode and day/night mode. Press MENU button until the economical temperature change screen opens up. Press \vee or \wedge to set the desired temperature.

Press MENU to confirm and move on to the next parameter or press EXIT to confirm and return to the main screen view.



4.12. PRE-SET TEMPERATURE HYSTERESIS

Room temperature hysteresis defines the pre-set temperature tolerance in order to prevent undesired oscillation in case of small temperature fluctuation (within the range of $0,2 \div 4^{\circ}\text{C}$).

In order to set the hysteresis, press MENU until the hysteresis setting screen opens up. Use ∇ or \blacktriangle to set the desired hysteresis value.

Press MENU to confirm and move on to the next parameter or press EXIT to confirm and return to the main screen view.

Example:

Pre-set temperature : 23°C

Hysteresis : 1°C

The room regulator reports that the temperature is too low only when the room temperature drops to 22°C .



4.13. TEMPERATURE SENSOR CALIBRATION

Calibration should be performed while mounting or after the regulator has been used for a long time, if the room temperature measured by the internal sensor differs from the actual temperature. Calibration setting range is from -10 to $+10^{\circ}\text{C}$ with the accuracy of $0,1^{\circ}\text{C}$. To calibrate the built-in sensor, press the MENU button until the temperature sensor calibration screen appears. Use the buttons ∇ \blacktriangle to set the desired correction.



To confirm, press the MENU button (confirm and go on to edit the next parameter) or press EXIT to confirm and return to the main screen view.

4.14. REGISTRATION

The description of the functions can be found in chapter IV. Wireless controller receiver - page 9.

4.15. FLOOR SENSOR



NOTE

- This parameter is not available in the menu when the additional sensor has not been connected to the floor sensor contact or when the cooling mode is active.

Use one of the buttons ∇ \blacktriangle to enable the floor sensor (ON) or disable it (OFF). To confirm, press the MENU button (confirm and go on to edit the next parameter) or press EXIT to confirm and return to the main screen view.



NOTE

- It is necessary to set this function to ON in order for the following parameters to be available in the controller menu: maximum floor temperature, floor sensor hysteresis, minimum floor temperature.

4.16. MAXIMUM FLOOR TEMPERATURE

In order to set the maximum floor temperature, enable floor heating and press MENU until the maximum floor temperature screen opens up. Next, use \checkmark or \wedge to set the maximum temperature.

To confirm, press the MENU button (confirm and go on to edit the next parameter) or press EXIT to confirm and return to the main screen view.



4.17. MINIMUM FLOOR TEMPERATURE

In order to set the minimum floor temperature, enable floor heating and press MENU until the minimum floor temperature screen opens up. Next, use \checkmark or \wedge to set the minimum temperature.

To confirm, press the MENU button (confirm and go on to edit the next parameter) or press EXIT to confirm and return to the main screen view.



4.18. FLOOR TEMPERATURE HYSTERESIS

Floor temperature hysteresis defines the pre-set temperature tolerance in order to prevent undesired oscillation in case of small temperature fluctuation within the range of $0,2 \div 4^\circ\text{C}$. In order to set the hysteresis, press MENU until the hysteresis screen opens up. Next, use \checkmark or \wedge to set the hysteresis. To confirm, press the MENU button (confirm and go on to edit the next parameter) or press EXIT to confirm and return to the main screen view.

Example:

Pre-set temperature: 23°C

Hysteresis: 1°C

The room regulator reports that the temperature is too low only when the room temperature drops to 22°C .

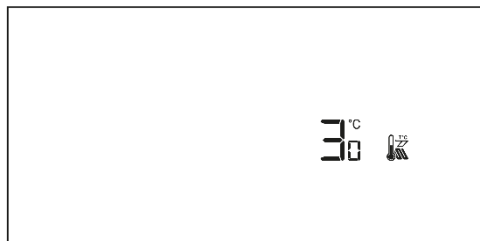

4.19. SERVICE MENU

Certain controller functions are secured with a code. They can be found in the service menu. In order to introduce changes in the service menu settings, press MENU until Service menu settings screen opens up. Next, use the buttons \checkmark \wedge to enter the code - 215. Select the first digit - 2 and confirm by holding the Menu button until the next digit starts flashing. Follow in the same way with the remaining digits of the code. Press MENU to confirm.

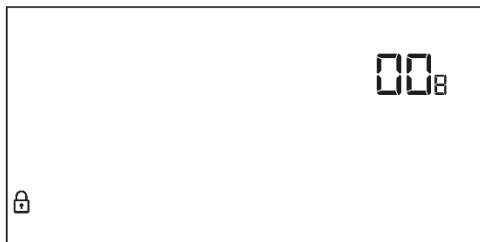

- **HEAT/ COOL mode**

This function enables the user to select the operation mode of the room regulator:

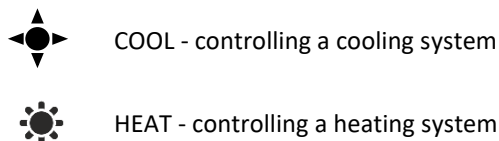

Use the buttons ∇ \blacktriangle to select the type of system to be controlled. To confirm, press the MENU button (confirm and go on to edit the next parameter) or press EXIT to confirm and return to the main screen view.



NOTE

- Cooling mode mustn't be selected in the case of using a floor sensor - it may lead to underfloor system damage.

- **How to edit the minimum (T1) and maximum (T2) pre-set temperature**

This function enables the user to set the minimum (T1) and the maximum (T2) pre-set room temperature. Select this option - the parameter starts flashing. Use the buttons ∇ \blacktriangle to set the temperature. To confirm, press the MENU button (confirm and go on to edit the next parameter) or press EXIT to confirm and return to the main screen view.

- **DEF factory settings**

This function enables the user to restore factory settings. In order to do it, select *Def* function and press MENU to confirm. Next, use the buttons ∇ \blacktriangle to select *YES* and conform by pressing MENU.

VII. TECHNICAL DATA

EU-293 B v2	
Power supply	2xAAA 1,5V batteries
Range of room temperature setting	5°C ÷ 35°C
Accuracy of measurement	± 0,5°C
Operation frequency	868 MHz
EU-293 Z v2	
Supply voltage	230V ± 10% / 50Hz
Maximum power consumption	0,5W
Operation frequency	868 MHz
Range of room temperature setting	5°C ÷ 35°C
Accuracy of measurement	± 0,5°C

EU-MW-3	
Supply voltage	230V ± 10% / 50Hz
Operation temperature	5°C ÷ 50°C
Maximum power consumption	<1W
Potential-free cont. nom. out. load	230V AC / 0,5A (AC1) * 24V DC / 0,5A (DC1) **
Operation frequency	868MHz
Maximum transmitting power	25mW

* AC1 load category: single-phase, resistive or slightly inductive AC load.

** DC1 load category: direct current, resistive or slightly inductive load.

*The pictures and diagrams are for illustration purposes only.
The manufacturer reserves the right to introduce some changes.*



Declaration of conformity

Hereby, we declare under our sole responsibility that **EU-293 v2/EU-293z v2** manufactured by TECH STEROWNIKI II Sp. z o.o., head-quartered in Wieprz Biała Droga 31, 34-122 Wieprz, is compliant with Directive **2014/53/EU** of the European parliament and of the Council of 16 April 2014 on the harmonisation of the laws of the Member States relating to the making available on the market of radio equipment, Directive **2009/125/EC** establishing a framework for the setting of ecodesign requirements for energy-related products as well as the regulation by the MINISTRY OF ENTREPRENEURSHIP AND TECHNOLOGY of 24 June 2019 amending the regulation concerning the essential requirements as regards the restriction of the use of certain hazardous substances in electrical and electronic equipment, implementing provisions of Directive (EU) 2017/2102 of the European Parliament and of the Council of 15 November 2017 amending Directive 2011/65/EU on the restriction of the use of certain hazardous substances in electrical and electronic equipment (OJ L 305, 21.11.2017, p. 8).

For compliance assessment, harmonized standards were used:

PN-EN IEC 60730-2-9 :2019-06 art. 3.1a Safety of use

PN-EN 62479:2011 art. 3.1 a Safety of use

ETSI EN 301 489-1 V2.2.3 (2019-11) art.3.1b Electromagnetic compatibility

ETSI EN 301 489-3 V2.1.1:2019-03 art.3.1 b Electromagnetic compatibility

ETSI EN 300 220-2 V3.2.1 (2018-06) art.3.2 Effective and coherent use of radio spectrum

ETSI EN 300 220-1 V3.1.1 (2017-02) art.3.2 Effective and coherent use of radio spectrum

EN IEC 63000:2018 RoHS.

Wieprz, 17.05.2021

Pawel Jura

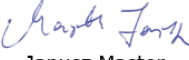
Janusz Master

Prezesa firmy

**TECH
TECH
CONTROLLERS**

Central headquarters:

ul. Biała Droga 31, 34-122 Wieprz

Service:

ul. Skotnica 120, 32-652 Bulowice

phone: **+48 33 875 93 80**

e-mail: **serwis@techsterowniki.pl**

www.tech-controllers.com